



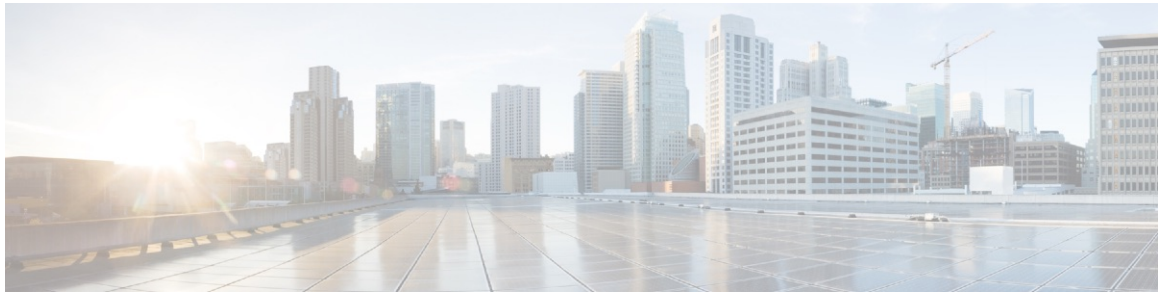
Cisco Catalyst PON Series Switches Hardware Installation Guide

First Published: 2020-11-08

Last Modified: 2021-09-26

Americas Headquarters

Cisco Systems, Inc.
170 West Tasman Drive
San Jose, CA 95134-1706
USA
<http://www.cisco.com>
Tel: 408 526-4000
800 553-NETS (6387)
Fax: 408 527-0883



CONTENTS

PREFACE

Preface **vii**

- Document Conventions **vii**
- Related Documentation **ix**
- Obtaining Documentation and Submitting a Service Request **ix**

CHAPTER 1

Introduction to Passive Optical Network **1**

- Cisco Catalyst PON Series OLT Overview **2**
 - Cisco Catalyst PON Series OLT Models **2**
 - Front Panel **3**
 - Rear Panel **4**
 - Ports **4**
 - Power Supply **5**
 - LEDs **6**
- Cisco Catalyst PON Series ONT Overview **7**
 - Cisco Catalyst PON Series ONT Models **8**
 - Front Panel **8**
 - Rear Panel **10**
 - Side Panel **10**
 - Top Panel **11**
 - Ports **13**
 - LEDs **13**
 - Lock Slot **15**
- Cisco Catalyst PON Manager Overview **15**

CHAPTER 2

Installation **17**

Safety Warnings	17
Box Contents	20
Installation Guidelines	22
Installing an OLT	22
Mounting the OLT on a Table or Shelf	22
Attaching the Rack-Mounting Bracket and Mounting a OLT on a Rack	23
Installing SFP or SFP+ Modules	24
Installing an SFP or SFP+ Module	24
Removing an SFP or SFP+ Module	25
Establishing the System Ground	25
Required Tools and Equipment	26
Connecting the System Ground	26
Connecting to the Power Source	28
Connecting to an AC Power Source	28
Connecting to a DC Power Source	29
Setting Up the OLT	30
Installing an ONT	30
Placing the ONT on a Table or Shelf	31
Installing the ONT on a Wall	31
Attaching the Rack-Mounting Bracket and Mounting an ONT on a Rack	33
Connecting to an AC Power Source	34
Setting Up an ONT	35
Installing Cisco Catalyst PON Manager	35
Setting Up Cisco Catalyst PON Manager	40
Starting PON Manager Server	40
Creating a New User in PON Manager Client	41

CHAPTER 3

Remove and Replace Field-Replaceable Units	45
Removing and Replacing a Fan Module	45
Installation Guidelines	45
Removing the Fan Module	45
Installing a Fan Module	47
Removing and Replacing the Power Supply Module	47
Installation Guidelines	47

Removing and Installing Power Supply Blank Cover	48
Removing a Power Supply Blank Cover	48
Installing a Power Supply Blank Cover	49
Removing a Power Supply Module from an OLT	49
Inserting the Power Supply Module in an OLT	52

CHAPTER 4

Troubleshoot 55

Troubleshooting Common Issues	55
Bad or Damaged Cable	55
Ethernet and Fiber-Optic Cables	55
Link Status	56
10/100/1000 PoE+ Port Connections	56
Cisco Catalyst PON Series OLT Troubleshooting	56
SFP and SFP+ Module	56
Fan Module	57
Power Supply Module	57
Interface Indicator	57
Finding a Cisco Catalyst PON OLT Serial Number	57
Cisco Catalyst PON Series ONT Troubleshooting	58
Finding the Cisco Catalyst PON ONT Serial Number	58

APPENDIX A

Technical Specifications 59

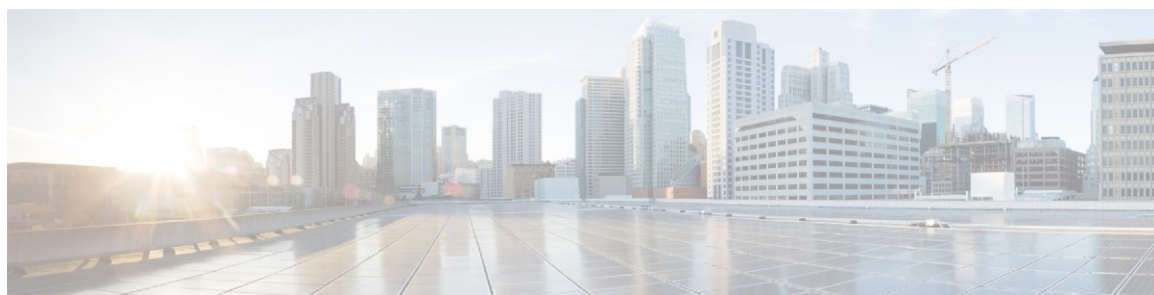
Cisco Catalyst PON Series OLT Technical Specifications	59
Physical Specifications	59
Environmental Specifications	59
Power Requirements	60
Cisco Catalyst PON Series ONT Technical Specifications	60
Physical Specifications	60
Environmental Specifications	61
Power Requirements	61

APPENDIX B

Connector and Cable Specifications 63

Connector Specifications	63
10/100/1000 Ports (Including PoE)	63

SFP Module Connectors	63
Cables and Adapters	64
Transceiver Module Network Cables	64
Cable Pinouts	65
Console Port Adapter Pinouts	66



Preface

This preface describes the conventions of this document and information on how to obtain other documentation. It also provides information on what's new in Cisco product documentation.



Note The documentation set for this product strives to use bias-free language. For purposes of this documentation set, bias-free is defined as language that does not imply discrimination based on age, disability, gender, racial identity, ethnic identity, sexual orientation, socioeconomic status, and intersectionality. Exceptions may be present in the documentation due to language that is hardcoded in the user interfaces of the product software, language used based on standards documentation, or language that is used by a referenced third-party product.

- [Document Conventions](#) , on page vii
- [Related Documentation](#), on page ix
- [Obtaining Documentation and Submitting a Service Request](#), on page ix

Document Conventions

This document uses the following conventions:

Convention	Description
<code>^</code> or <code>Ctrl</code>	Both the <code>^</code> symbol and <code>Ctrl</code> represent the Control (<code>Ctrl</code>) key on a keyboard. For example, the key combination <code>^D</code> or <code>Ctrl-D</code> means that you hold down the Control key while you press the D key. (Keys are indicated in capital letters but are not case sensitive.)
bold font	Commands and keywords and user-entered text appear in bold font.
<i>Italic</i> font	Document titles, new or emphasized terms, and arguments for which you supply values are in <i>italic</i> font.
<code>Courier</code> font	Terminal sessions and information the system displays appear in <code>courier</code> font.
Bold Courier font	Bold Courier font indicates text that the user must enter.
[x]	Elements in square brackets are optional.

Convention	Description
...	An ellipsis (three consecutive nonbolded periods without spaces) after a syntax element indicates that the element can be repeated.
	A vertical line, called a pipe, indicates a choice within a set of keywords or arguments.
[x y]	Optional alternative keywords are grouped in brackets and separated by vertical bars.
{x y}	Required alternative keywords are grouped in braces and separated by vertical bars.
[x {y z}]	Nested set of square brackets or braces indicate optional or required choices within optional or required elements. Braces and a vertical bar within square brackets indicate a required choice within an optional element.
string	A nonquoted set of characters. Do not use quotation marks around the string or the string will include the quotation marks.
<>	Nonprinting characters such as passwords are in angle brackets.
[]	Default responses to system prompts are in square brackets.
!, #	An exclamation point (!) or a pound sign (#) at the beginning of a line of code indicates a comment line.

Reader Alert Conventions

This document may use the following conventions for reader alerts:



Note Means *reader take note*. Notes contain helpful suggestions or references to material not covered in the manual.



Tip Means *the following information will help you solve a problem*.



Caution Means *reader be careful*. In this situation, you might do something that could result in equipment damage or loss of data.



Timesaver Means *the described action saves time*. You can save time by performing the action described in the paragraph.

**Warning****IMPORTANT SAFETY INSTRUCTIONS**

This warning symbol means danger. You are in a situation that could cause bodily injury. Before you work on any equipment, be aware of the hazards involved with electrical circuitry and be familiar with standard practices for preventing accidents. Use the statement number provided at the end of each warning to locate its translation in the translated safety warnings that accompanied this device. Statement 1071

SAVE THESE INSTRUCTIONS

Related Documentation

The following related documentation are available:

- Cisco Catalyst GPON Release Note
- Cisco Catalyst GPON OLT Configuration Guide
- Cisco Catalyst GPON OLT Command Reference
- Cisco Catalyst GPON ONT Configuration Guide
- Cisco Catalyst GPON Regulatory Compliance and Safety Information

Obtaining Documentation and Submitting a Service Request

For information on obtaining documentation, submitting a service request, and gathering additional information, see the monthly *What's New in Cisco Product Documentation*, which also lists all new and revised Cisco technical documentation, at:

<http://www.cisco.com/c/en/us/td/docs/general/whatsnew/whatsnew.html>

Subscribe to the *What's New in Cisco Product Documentation* as a Really Simple Syndication (RSS) feed and set content to be delivered directly to your desktop using a reader application. The RSS feeds are a free service and Cisco currently supports RSS version 2.0.



CHAPTER 1

Introduction to Passive Optical Network

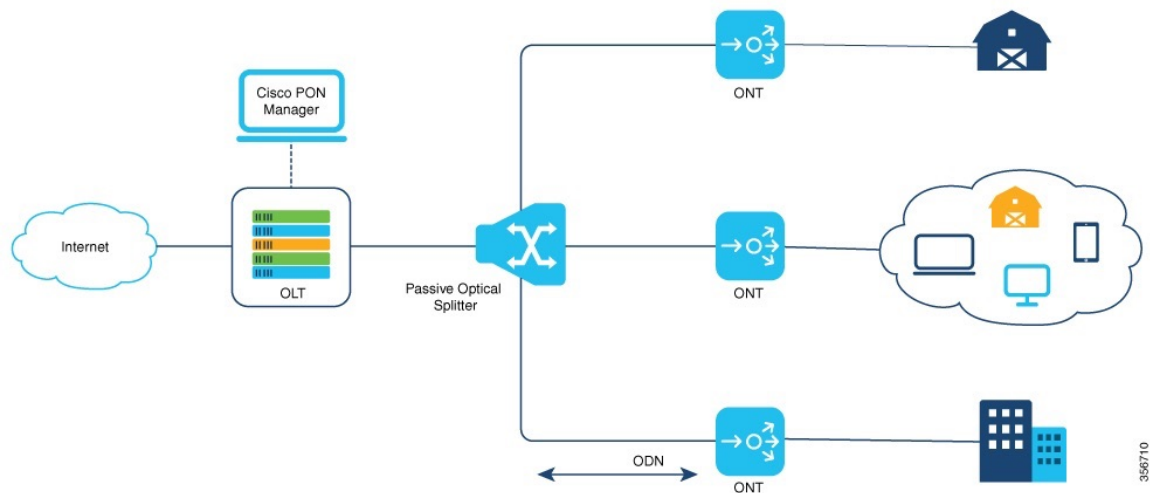
A passive optical network (PON) or Gigabit Passive Optical Network (GPON) is a point-to-multipoint (P2MP) network that uses a combination of active transmission equipments and passive cable components to provide network connectivity to end user's devices. This network is suitable for building access networks such as fiber-to-the-home (FTTH), or fiber-to-the-office (FTTO), or fiber-to-the-company (FTTC) for providing internet access by running fiber optic cable directly from an internet service provider to a user's home or business. The PON technology is based on the ITU-T G.984 standard.

PON transmits Ethernet, Asynchronous Transfer Mode (ATM), and Time Division Multiplexing (TDM) traffic. It consists of mainly two active transmission equipments, Optical Line Terminal (OLT) and Optical Network Terminal (ONT). One of the main characteristics of PON is the use of passive optical splitters in the fiber distribution network, enabling a single feeding fiber from the service provider's central office to serve multiple homes and small businesses.

The network path between the terminals is known as Optical Device Network (ODN), which comprises passive optical components, such as optical fibers and passive optical splitters. The ODN provides optical channels that interconnect the OLT to the ONTs. The optical fiber cables cover a distance of 20km to 30km.

A single optical fiber from the OLT connects to a passive optical splitter that is located near an end user's premises. The optical splitter divides optical power into n separate paths to end user. The number of optical paths can vary from 2 to 128. From the optical splitter, a single-mode fiber strand is connected to each end user's devices. Data is broadcast in the downstream direction and transmitted in the TDMA mode based on timeslots in the upstream direction.

Figure 1: Components of GPON



The data, voice, and video signals of an end-user devices are sent to ONTs. The signals are converted into GPON Encapsulation Method (GEM) frames and then transmitted over optical fibers to the OLT using the PON uplink ports on the ONTs. On the OLT the GEM frames are converted into Ethernet packets and are forwarded to the upper-layer IP network using the uplink port on the OLT.

For more information, see the following sections:

- [Cisco Catalyst PON Series OLT Overview, on page 2](#)
- [Cisco Catalyst PON Series ONT Overview, on page 7](#)
- [Cisco Catalyst PON Manager Overview, on page 15](#)

Cisco Catalyst PON Series OLT Overview

The Cisco Catalyst PON Series OLT is an aggregation device that is located at a service provider's central office of the PON network. The main functions of a Cisco Catalyst PON Series OLT are traffic scheduling, buffer control, and bandwidth allocation. The Cisco Catalyst PON Series OLT manages the network traffic that is in the form of video, data, and voice signals in a PON network, and sends them downstream to the Cisco Catalyst PON Series ONTs on the network. The Cisco Catalyst PON Series OLT also receives the signals from the Cisco Catalyst PON Series ONTs located at an end user's premises and sends them to their destination over the internet.

A Cisco Catalyst PON Series OLT can support up to 128 Cisco Catalyst PON Series ONTs per port. A Cisco Catalyst PON Series OLT provides 8/16xPON ports, 4xG combo ports and 2x10G small form-factor pluggable (SFP+) ports for uplink. A Cisco Catalyst PON Series OLT carries abundant services and flexible network mode over one optical network, and is especially suitable for networks such as enterprise LAN, video application, and high-speed internet.

Cisco Catalyst PON Series OLT Models

The following table lists the Cisco Catalyst PON Series OLT models and their description.

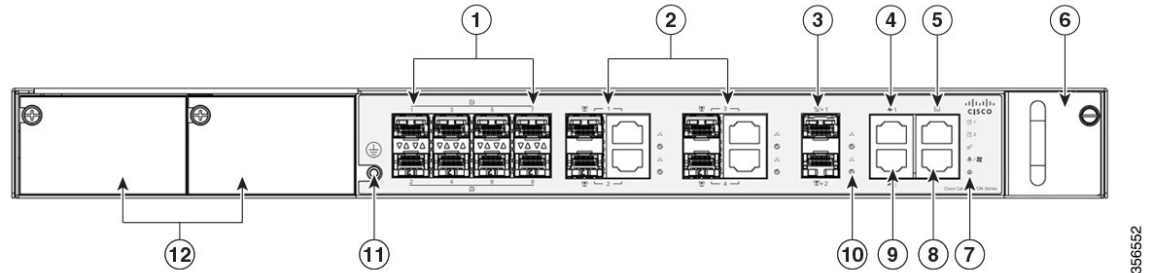
Table 1: Cisco Catalyst PON Series OLT Models and Description

Model	Description
CGP-OLT-8T	Cisco Catalyst PON Series OLT with 8xPON port, 4x1 G combo port, and 2x10 G SFP+ module uplink slot.
CGP-OLT-16T	Cisco Catalyst PON Series OLT with 16xPON port, 4x1 G combo port, and 2x10 G SFP+ module uplink slot.

Front Panel

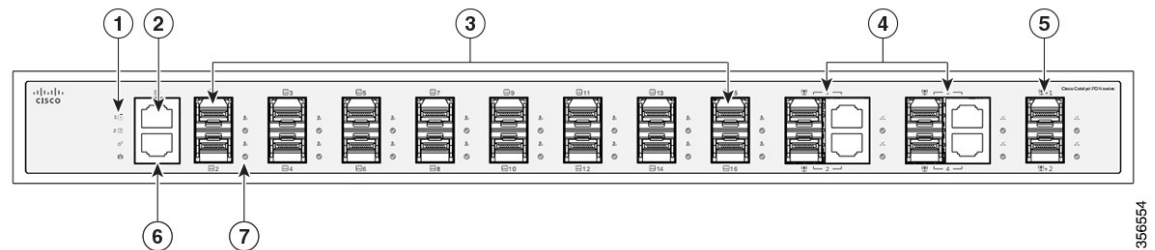
This section describes the front-panel components of Cisco Catalyst PON Series OLT.

Figure 2: Front Panel of CGP-OLT-8T



1	PON ports	7	System LEDs
2	1 G combo ports	8	Auxiliary port
3	10 G SFP+ ports	9	Reserve alarm port
4	Reserve alarm port	10	Port LEDs
5	Console port	11	Grounding connector
6	Fan module	12	Power modules

Figure 3: Front Panel of CGP-OLT-16T



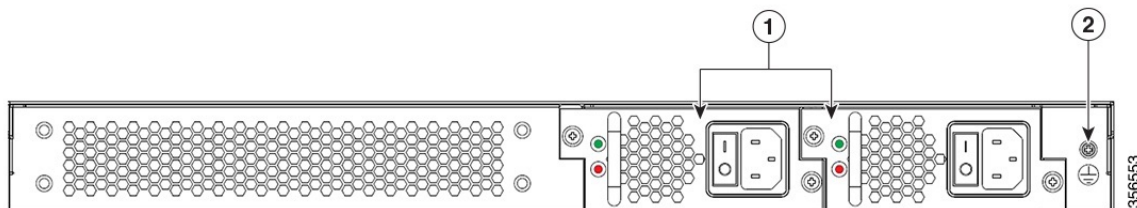
1	System LEDs	5	10 G SFP+ port
2	Console port	6	Auxiliary port

3	PON ports	7	Port LEDs
4	1 G combo ports	-	-

Rear Panel

This section describes the rear-panel components of CGP-OLT-16T:

Figure 4: Rear Panel of CGP-OLT-16T



1	AC or DC power connector	2	Grounding connector
---	--------------------------	---	---------------------

Ports

PON Ports

The PON ports use multi-source agreement (MSA) type UPC or SC-PC fiber connector. The PON ports support a bandwidth of 2.466 Gbps downstream and 1.244 Gbps upstream.

Console Port

The console port connects the Cisco Catalyst PON Series OLT to a PC running Microsoft Windows or to a terminal server and uses the RJ-45 crossover cable. The RJ-45 console port connection uses the supplied RJ-45-to-DB-9 female cable.

Auxiliary Port

The auxiliary port connects the Cisco Catalyst PON Series OLT to a host such as a Windows workstation or a terminal server through the auxiliary port. The auxiliary out-of-band management port is a virtual routing and forwarding (VRF) interface and uses an RJ-45 crossover cable.

1 G Combo Ports

A combo port is a combination of an SFP interface and an RJ-45 port. When the SFP interface is active, the adjacent RJ-45 port is disabled. The 1 G ports use LC connectors for fiber-optic connections and RJ-45 connectors for copper connections.

10 G SFP+ Ports

The 10 G ports use LC connector cables for fiber-optic connections and RJ-45 connector cables for copper connections. The SFP slots support only SFP+ modules. These SFP+ modules are field replaceable, and provide uplink interfaces when installed in an SFP+ module slot.

For more information on compatible Cisco SFP+ modules, see the [Cisco Catalyst PON Series Switches Release Notes](#).

Reserve Alarm Port

The reserve alarm port connects to external monitoring systems such as the Environment Monitor System.



Note This functionality is currently disabled.

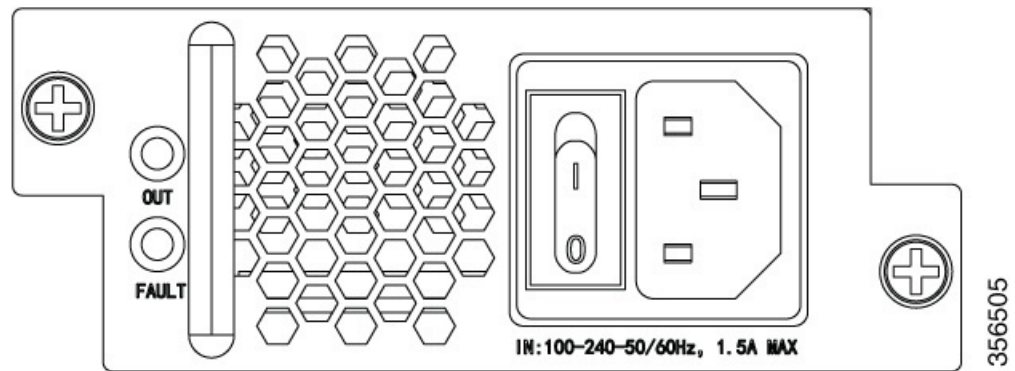
Power Supply

The Cisco Catalyst PON Series OLT chassis has redundant power supply slots that operate with one or two power supply modules. The chassis supports field-replaceable AC-input and DC-input power supply modules.



Note Hybrid power supply plugs are not supported.

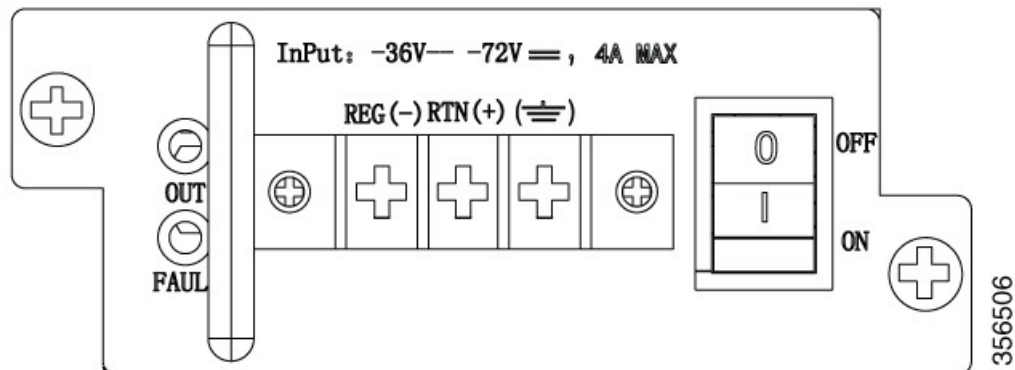
AC Power Supply



The following table lists the power supply ratings.

Input Voltage (VAC)	Output Power (Watts)
220	100
110	100

DC Power Supply



The following table lists the power supply ratings.

Input Voltage (VAC)	Output Power (Watts)
-36 to -72VDC (with extended range upto -75VDC) Voltage differential between inputs is unlimited.	100

LEDs

You can use LEDs to monitor the activity and performance of Cisco Catalyst PON Series OLT.

Table 2: System LEDs

LED	Color	Indication
PWR1 and PWR2	Green (solid)	Normal power from power supply
	OFF	No power from power supply
RUN	Green (blinking)	OLT is running normally
	OFF	OLT is not running
	or Green (solid)	or OLT is running abnormally
AUX	OFF	Auxiliary port is not connected
	Green (solid)	Auxiliary port is connected, but not transmitting data
	Green (blinking)	Auxiliary port is connected and is transmitting data
OUT	Green (solid)	Power supply is normal
	OFF	No power supply

LED	Color	Indication
FAULT	Red (Solid)	Power supply is abnormal
	OFF	Power supply is normal

Table 3: Port LEDs

LED	Color	Indication
PON port		
REG	Green (solid)	ONT is registered on the OLT.
	OFF	No ONT is registered on the OLT.
ACT	Green (blinking)	OLT is receiving and transmitting data
	OFF	OLT is not receiving and transmitting data
1 G port and 10 G port		
LINK	Green (solid)	Connection is established
	OFF	No connection
ACT	Green (blinking)	OLT is receiving and transmitting data
	OFF	OLT is not receiving and transmitting data

Cisco Catalyst PON Series ONT Overview

The Cisco Catalyst PON Series ONT is an optical modem device that is integrated with powerful interoperability and high performance. (An ONT is also referred to as Optical Network Unit [ONU]. ONT is an ITU-T term, while ONU is an IEEE term.) The Cisco Catalyst PON ONT is located at an end user's premises. The Cisco Catalyst PON Series ONT connects to the PON network on one side and accesses the end user's devices in FTTH, or FTTO, or FTTC service delivery architecture on the other side. The Cisco Catalyst PON Series ONT communicates between the Cisco Catalyst PON Series OLT and the end-user devices.

In the upstream direction, a Cisco Catalyst PON Series ONT is connected to the optical splitter through the PON port. The data, voice, and video signals from end user's devices are sent to the Cisco Catalyst PON Series ONT. Using the uplink ports on the Cisco Catalyst PON Series ONT, these signals are converted into electrical signals and transmitted over optical fibers to the Cisco Catalyst PON Series OLT. In the downstream direction, the Cisco Catalyst PON Series ONT is connected to various end user devices using the 1 G ports and provides triple-play services such as high-speed internet (HSI), voice (VoIP), and video (IPTV and RF overlay).

Cisco Catalyst PON Series ONT provides 1xPON port, 4x1 G 10/100/1000 PoE port, and 1xUSB Type A port with 2xForeign Exchange Station (FXS) port, and 1xcoaxial cable television (CATV) port, which is optional.

Cisco Catalyst PON Series ONT Models

The following table lists the Cisco Catalyst PON Series ONT models and their description.

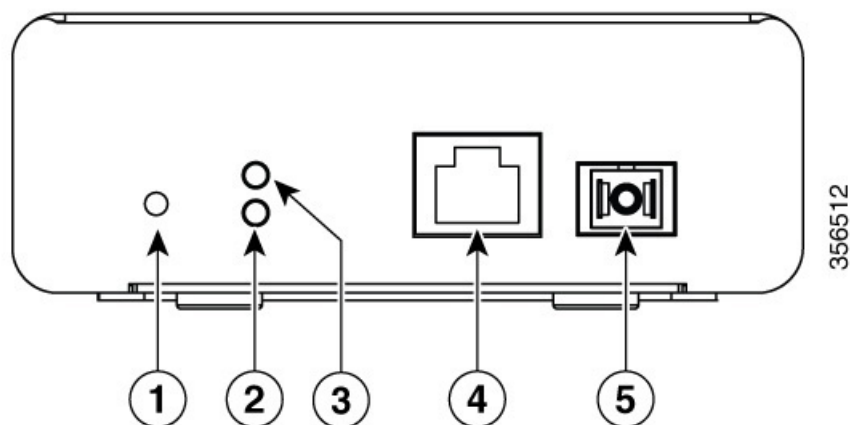
Table 4: Cisco Catalyst PON Series ONT Models and Description

ONT Model	Description
CGP-ONT-1P	Cisco Catalyst PON ONT with 1xPON port and 1x1 G 10/100/1000 PoE port.
CGP-ONT-4P	Cisco Catalyst PON ONT with 1xPON port, 4x1 G 10/100/1000 PoE port, and 1xUSB Type A port.
CGP-ONT-4PV	Cisco Catalyst PON ONT with 1xPON port, 4x1 G 10/100/1000 PoE port, 1xUSB Type A port, and 2xFXS port.
CGP-ONT-4PVC	Cisco Catalyst PON ONT with 1xPON port, 4x1 G 10/100/1000 PoE port, 1xUSB Type A port, 2xFXS port, and 1xCATV port.
CGP-ONT-4TVCW	Cisco Catalyst PON ONT with 1xPON port, 4x1 G 10/100/1000 port, 2xFXS port, 1xUSB Type A port, 1xCATV port, and supports 802.11ac wireless.

Front Panel

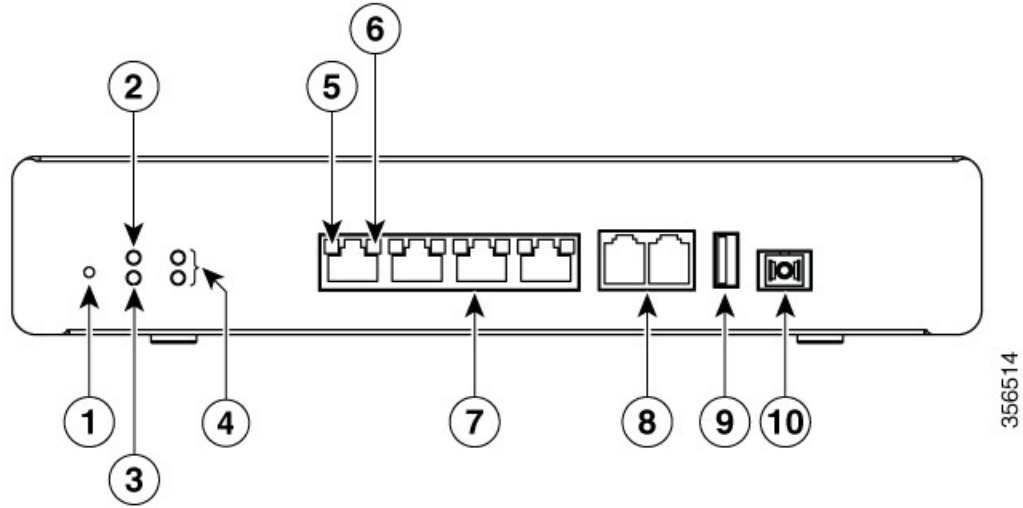
This section describes the front-panel components of a Cisco Catalyst PON Series ONT.

Figure 5: Front panel of CGP-ONT-1P



1	Reset button	4	1 G port
2	PON LED	5	PON port
3	Power LED	-	-

Figure 6: Front Panel of CGP-ONT-4PVC

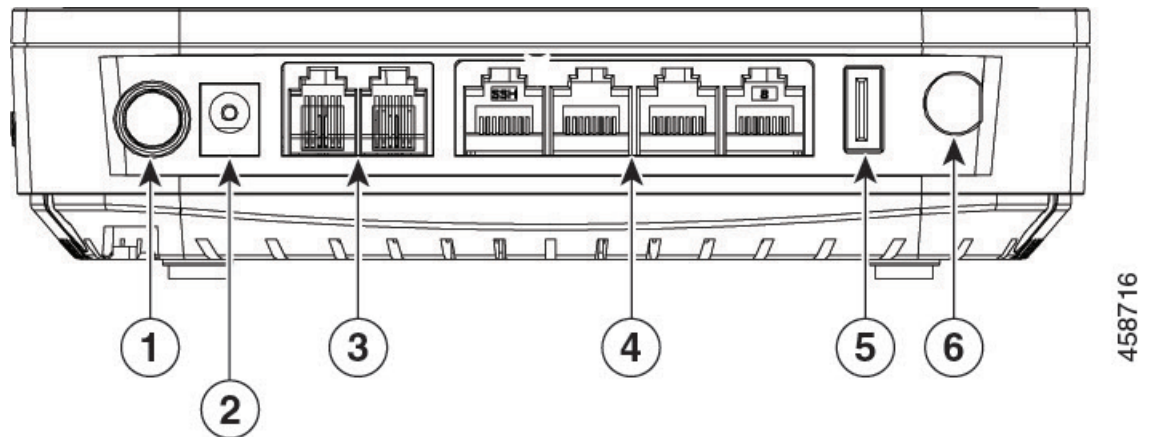


1	Reset button	6	PoE LED
2	Power LED	7	1 G ports
3	PON LED	8	FXS ports ¹
4	FXS LED ²	9	USB port
5	1 G LED	10	PON port

¹ Not available on all ONT models

² Not available on all ONT models

Figure 7: Front panel of CGP-ONT-4TVCW



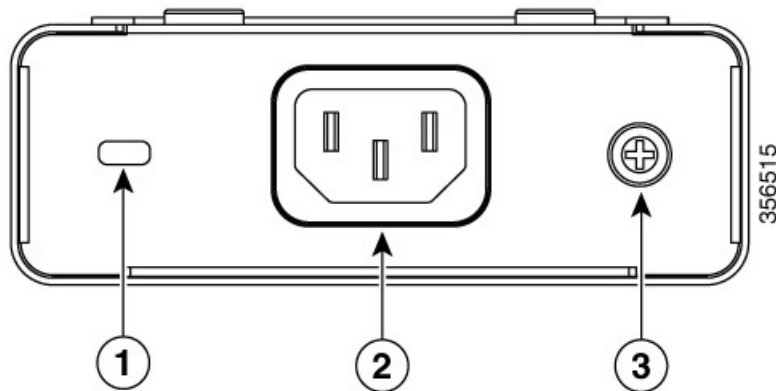
1	Power button	4	1 G ports
2	DC power connector	5	USB Type A port

3	FXS ports	6	CATV port
---	-----------	---	-----------

Rear Panel

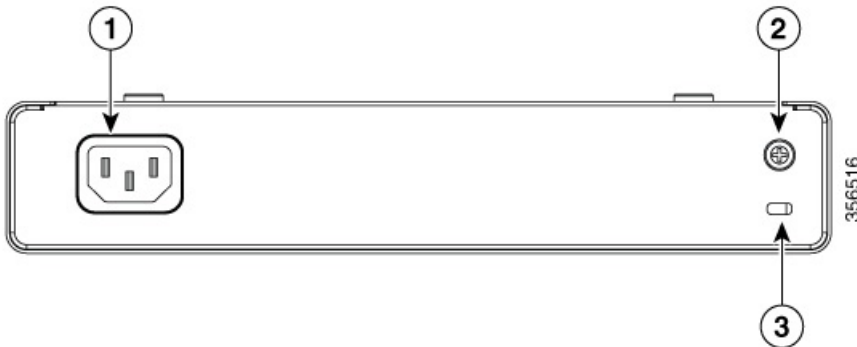
The section describes the rear-panel components of a Cisco Catalyst PON Series ONT.

Figure 8: Rear panel of CGP-ONT-1P



1	Lock slot	3	Grounding connector
2	AC power connector	-	-

Figure 9: Rear Panel of CGP-ONT-4PVC

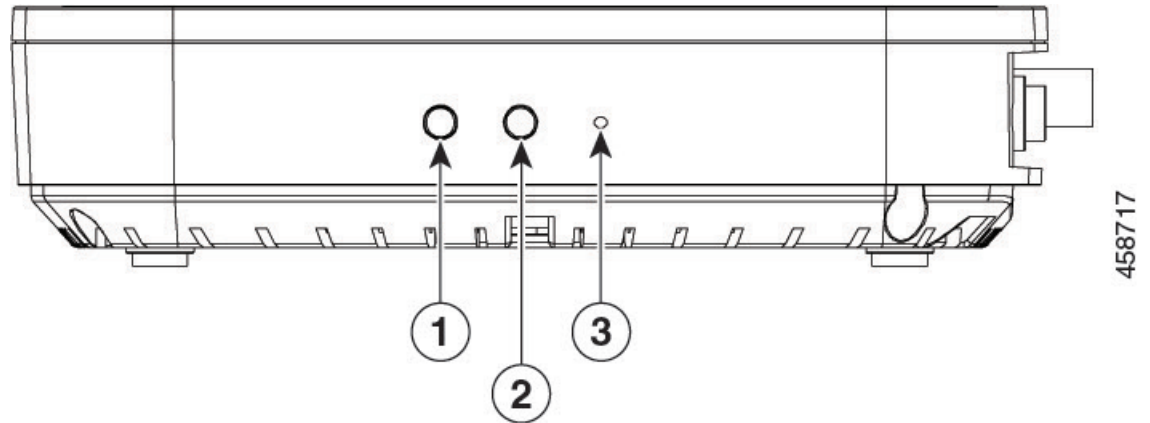


1	AC power connector	3	Lock slot
2	Grounding connector	-	-

Side Panel

The section describes the side-panel components of CGP-ONT-4TVCW.

Figure 10: Side Panel of CGP-ONT-4TVCW

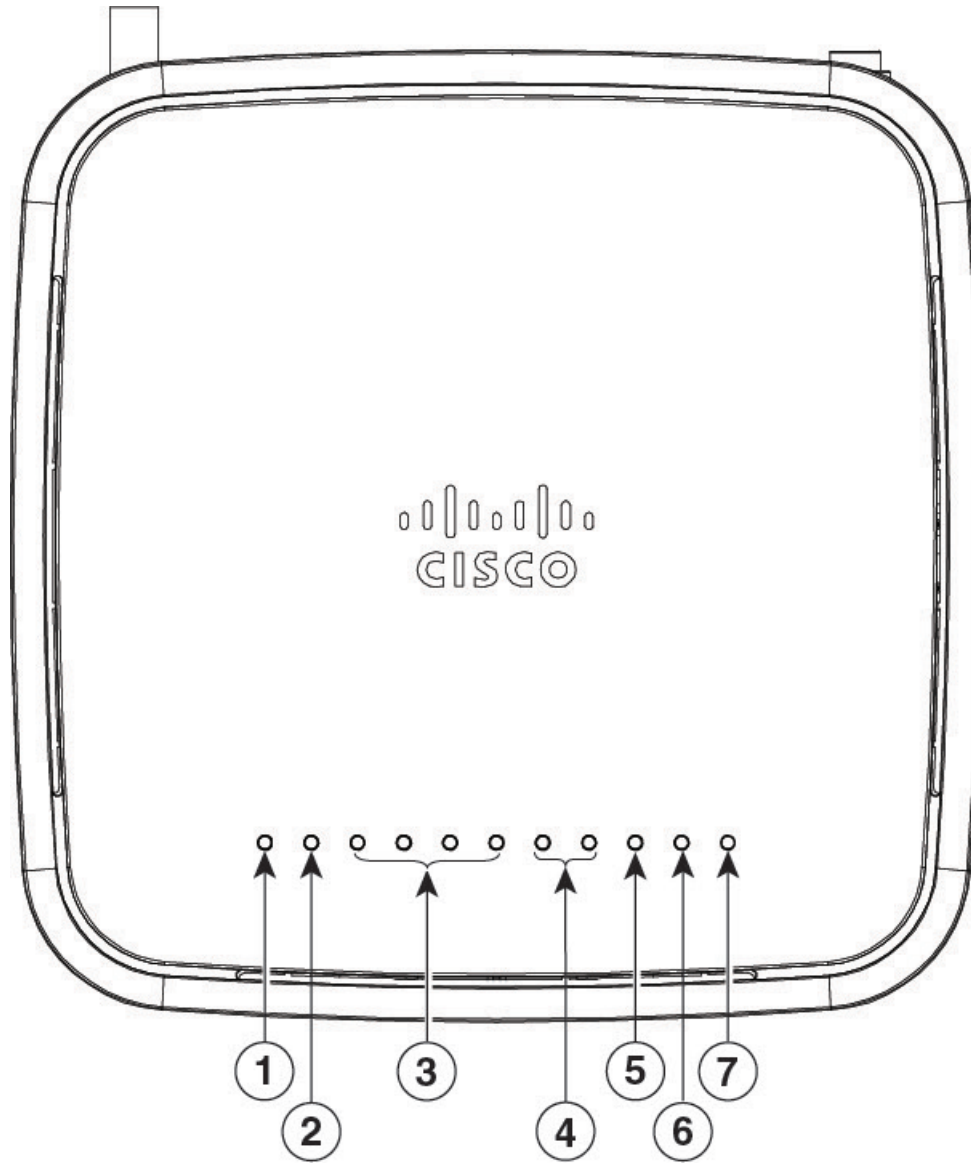


1	Light button	3	Reset button
2	WiFi button	-	-

Top Panel

This section describes the top-panel components of CGP-ONT-4TVCW.

Figure 11: Top panel of CGP-ONT-4TVCW



458718

1	Power LED	5	CATV LED
2	PON LED	6	2.4 GHz LED
3	1 G LED	7	5 GHz LED
4	FXS LED	-	-

Ports

1 G 10/100/1000 PoE Ports

The Ethernet ports use RJ-45 connector cables with Ethernet pinouts. The 10BASE-T, 100BASE-TX, and 1000BASE-T traffic requires Category 5 or Category 5e twisted pair (UTP) cable. The 10BASE-T traffic can use Category 3 or Category 4 UTP cable.

The ports also provide PoE support for devices that are compliant with IEEE 802.3af and IEEE 802.3at.

FXS Ports

The FXS ports use RJ-11 telephone cables.

PON Port

The PON ports use multi-source agreement (MSA) type UPC or SC-PC fiber connector cables. The PON ports range is from 8 to -29 dBm.

USB Port

A USB type A console port is provided for log and configuration file management.

CATV Port

The CATV port uses a coaxial cable.

LEDs

You can use the LEDs to monitor the activity and performance of Cisco Catalyst PON Series ONT.

Table 5: LEDs on CGP-ONT-1P, CGP-ONT-4P, CGP-ONT-4PV, and CGP-ONT-4PVC

LED	Color	Indication
PWR	Green (solid)	Normal power from power supply.
	OFF	No power from power supply.
PON	Green (solid)	ONT is active and registered successfully.
	Green (flashing)	ONT is either inactive or being registered.
	Red (flashing)	Loss in optical signal power.
	OFF	PON module is not ready.
1 G (1–4)		
Right LED	Amber (solid)	Power device is connected.
	OFF	Power device is not connected.

LED	Color	Indication
Left LED	Green (solid)	Link is up but is not transmitting data.
	Green (flashing)	Link is up and transmitting data.
	OFF	Link is down.
FXS (1–2)	Green (solid)	Softswitch is successfully registered.
	Green (flashing)	Calling or being called.
	OFF	Softswitch is not successfully registered.
CATV	Green (solid)	Cable is connected and input power is within normal range (-15 to -5 dBm).
	OFF	Cable is either not connected or cable is connected but input power is not within normal range.

Table 6: LEDs on CGP-ONT-4TVCW

LED	Color	Indication
PWR	Green (solid)	Normal power from power supply.
	OFF	No power from power supply.
PON	Green (solid)	ONT is active and registered successfully.
	Green (flashing)	ONT is either inactive or being registered.
	Red (flashing)	Loss in optical signal power.
	OFF	PON module is not ready.
1 G (1–4)	Green (solid)	Link is up but is not transmitting data.
	Green (flashing)	Link is up and transmitting data.
	OFF	Link is down.

LED	Color	Indication
FXS (1–2)	Green (solid)	Softswitch is successfully registered.
	Green (flashing)	Calling or being called.
	OFF	Softswitch is not successfully registered.
CATV	Green (solid)	Cable is connected and input power is within normal range (-15 to -5 dBm).
	OFF	Cable is not connected or cable is connected but input power is not within normal range.
2.4 GHz	Green (flashing)	802.11ac wireless transmitting at 2.4 GHz.
	OFF	2.4 GHz radio is disabled.
5 GHz	Green (flashing)	802.11ac wireless transmitting at 5 GHz.
	OFF	5 GHz radio is disabled.

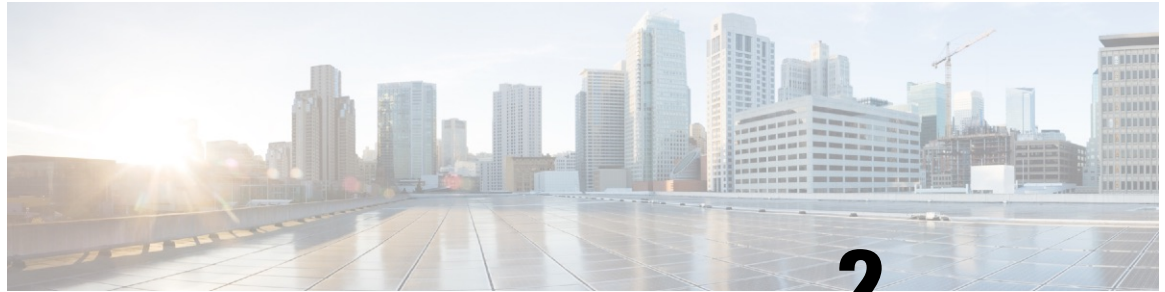
Lock Slot

The Cisco Catalyst PON Series ONT has a lock slot on the rear panel. You can install an optional cable lock, such as the type that is used to secure a laptop computer, to secure the Cisco Catalyst PON Series ONT.

Cisco Catalyst PON Manager Overview

Cisco Catalyst PON Manager is a software platform with highly customized and scalable network management. Based on the configurations, Cisco Catalyst PON Manager can automatically discover various data devices on the network, and dynamically design the network topology. The intuitive network topology allows easy monitoring and managing of networks and devices in each network.

The Cisco Catalyst PON Manager works on a client-server model and operates on Windows operating system.



CHAPTER 2

Installation

- [Safety Warnings, on page 17](#)
- [Box Contents, on page 20](#)
- [Installation Guidelines, on page 22](#)
- [Installing an OLT, on page 22](#)
- [Installing an ONT, on page 30](#)
- [Installing Cisco Catalyst PON Manager, on page 35](#)

Safety Warnings

This section includes the warning statements relating to the basic installation. We recommend that you read this section before you start the installation procedure.



Warning

Before working on equipment that is connected to power lines, remove jewelry (including rings, necklaces, and watches). Metal objects will heat up when connected to power and ground and can cause serious burns or weld the metal object to the terminals. **Statement 43**



Warning

Do not stack the chassis on any other equipment. If the chassis falls, it can cause severe bodily injury and equipment damage. **Statement 48**



Warning

To comply with FCC radio frequency (RF) exposure limits, antennas should be located at a minimum of 7.87 inches (20 cm) or more from the body of all persons. **Statement 332**



Warning

Read the wall-mounting instructions carefully before beginning installation. Failure to use the correct hardware or to follow the correct procedures could result in a hazardous situation to people and damage to the system. **Statement 378**



Warning Do not work on the system or connect or disconnect cables during periods of lightning activity. **Statement 1001**



Warning Read the installation instructions before connecting the system to the power source. **Statement 1004**



Warning To prevent bodily injury when mounting or servicing this unit in a rack, you must take special precautions to ensure that the system remains stable. The following guidelines are provided to ensure your safety:

- This unit should be mounted at the bottom of the rack if it is the only unit in the rack.
- When mounting this unit in a partially filled rack, load the rack from the bottom to the top with the heaviest component at the bottom of the rack.
- If the rack is provided with stabilizing devices, install the stabilizers before mounting or servicing the unit in the rack.

Statement 1006



Warning Class 1 laser product. **Statement 1008**



Warning This unit is intended for installation in restricted access areas. A restricted access area can be accessed only through the use of a special tool, lock and key, or other means of security. **Statement 1017**



Warning The plug-socket combination must be accessible at all times, because it serves as the main disconnecting device. **Statement 1019**



Warning This equipment must be grounded. Never defeat the ground conductor or operate the equipment in the absence of a suitably installed ground conductor. Contact the appropriate electrical inspection authority or an electrician if you are uncertain that suitable grounding is available. **Statement 1024**



Warning Only trained and qualified personnel should be allowed to install, replace, or service this equipment. **Statement 1030**



Warning Ultimate disposal of this product should be handled according to all national laws and regulations. **Statement 1040**



Warning For connections outside the building where the equipment is installed, the following ports must be connected through an approved network termination unit with integral circuit protection: 10/100/1000 Ethernet. **Statement 1044**



Warning When installing or replacing the unit, the ground connection must always be made first and disconnected last. **Statement 1046**



Warning To prevent the system from overheating, do not operate it in an area that exceeds the maximum recommended ambient temperature of: <104°F (40°C). **Statement 1047**



Note The maximum operating temperature is 40°C.



Warning Invisible laser radiation may be emitted from disconnected fibers or connectors. Do not stare into beams or view directly with optical instruments. **Statement 1051**



Warning This warning symbol means danger. You are in a situation that could cause bodily injury. Before you work on any equipment, be aware of the hazards involved with electrical circuitry and be familiar with standard practices for preventing accidents. Use the statement number provided at the end of each warning to locate its translation in the translated safety warnings that accompanied this device. **Statement 1071**



Warning Voltages that present a shock hazard may exist on Power over Ethernet (PoE) circuits if interconnections are made using uninsulated exposed metal contacts, conductors, or terminals. Avoid using such interconnection methods, unless the exposed metal parts are located within a restricted access location and users and service people who are authorized within the restricted access location are made aware of the hazard. A restricted access area can be accessed only through the use of a special tool, lock and key or other means of security. **Statement 1072**



Warning No user-serviceable parts inside. Do not open. **Statement 1073**



Warning Installation of the equipment must comply with local and national electrical codes. **Statement 1074**



Warning To prevent airflow restriction, allow clearance around the ventilation openings to be at least: 3 inches (7.6 cm). **Statement 1076**



Warning Hot surface. **Statement 1079**

Box Contents

This section lists the contents of the shipping box.

Cisco Catalyst PON Series OLT and Accessories

Table 7: Cisco Catalyst PON Series OLT and Accessories

Component	Description	Quantity
Model	CGP-OLT-8T	1
	CGP-OLT-16T	
Accessories	Mounting brackets	2
	Rubber mounting feet	4
	Power cord	1
	Grounding wire	1
	Mounting brackets to chassis screws	6
	Mounting brackets to cabinet screws #10	4
	Mounting brackets to cabinet screws #12	4
	Pointer card	1

Cisco Catalyst PON Series ONT and Accessories

Table 8: CGP-ONT-1P and Accessories

Component	Description	Quantity
Model	CGP-ONT-1P	1

Component	Description	Quantity
Accessories	Mounting bracket	1
	Rubber mounting feet	4
	RJ-45 to RJ-45 crossover cable	1
	Power cord	1
	Mounting brackets screws	4
	Pointer card	1

Table 9: CGP-ONT-4P, CGP-ONT-4PV, CGP-ONT-4PVC, and Accessories

Component	Description	Quantity
Model	CGP-ONT-4P	1
	CGP-ONT-4PV	
	CGP-ONT-4PVC	
Accessories	Mounting brackets	2
	Rubber mounting feet	4
	RJ-45 to RJ-45 crossover cable	1
	Power cord	1
	Mounting brackets to chassis screws	8
	Mounting brackets to cabinet screws #10	4
	Mounting brackets to cabinet screws #12	4
	Pointer card	1

Table 10: CGP-ONT-4TVCW and Accessories

Component	Description	Quantity
Model	CGP-ONT-4TVCW	1
Accessories	RJ-45 to RJ-45 crossover cable	1
	Power adapter	1
	Pointer card	1

Installation Guidelines

When determining where to install the device, verify that these guidelines are met:

- Clearance to the device's front and rear panel meets these conditions:
 - Front-panel LEDs can be easily read.
 - Access to ports is sufficient for unrestricted cabling.
 - AC power cord can reach from the AC power outlet to the connector on the device rear panel.
- Cabling is away from sources of electrical noise, such as radios, power lines, and fluorescent lighting fixtures. Make sure that the cabling is safely away from other devices that might damage the cables.
- Make sure that power supply modules are securely inserted into the chassis before moving the switch.
- Airflow around the switch and through the vents is unrestricted.
- Temperature around the unit does not exceed 104°F (40°C). If the switch is installed in a closed or multirack assembly, the temperature around it might be greater than normal room temperature.
- Humidity around the switch does not exceed 90 percent.
- Altitude at the installation site is not greater than 5,000 feet (1524 meters).
- For 10/100/1000 fixed ports, the cable length from the Cisco Catalyst PON Series ONT to a connected device cannot exceed 328 feet (100 meters).
- Cooling mechanisms, such as fans and blowers in the device, can draw dust and other particles causing contaminant buildup inside the device, which might result in system malfunction. You must install this equipment in an environment as free from dust and foreign conductive material (such as metal flakes from construction activities) as is possible.

Installing an OLT

The following sections provide information about the various tasks that comprise the Cisco Catalyst PON Series OLT installation.

Mounting the OLT on a Table or Shelf

Procedure

- Step 1** Locate the adhesive strip with the rubber feet in the mounting-kit envelope.
 - Step 2** Attach the four rubber feet to the four circular etches on the bottom of the OLT.
 - Step 3** Place the OLT on a table or shelf near an AC power source.
-

Attaching the Rack-Mounting Bracket and Mounting a OLT on a Rack



Warning To prevent bodily injury when mounting or servicing this unit in a rack, you must take special precautions to ensure that the system remains stable. The following guidelines are provided to ensure your safety:

- This unit should be mounted at the bottom of the rack if it is the only unit in the rack.
- When mounting this unit in a partially filled rack, load the rack from the bottom to the top with the heaviest component at the bottom of the rack.
- If the rack is provided with stabilizing devices, install the stabilizers before mounting or servicing the unit in the rack.

Statement 1006

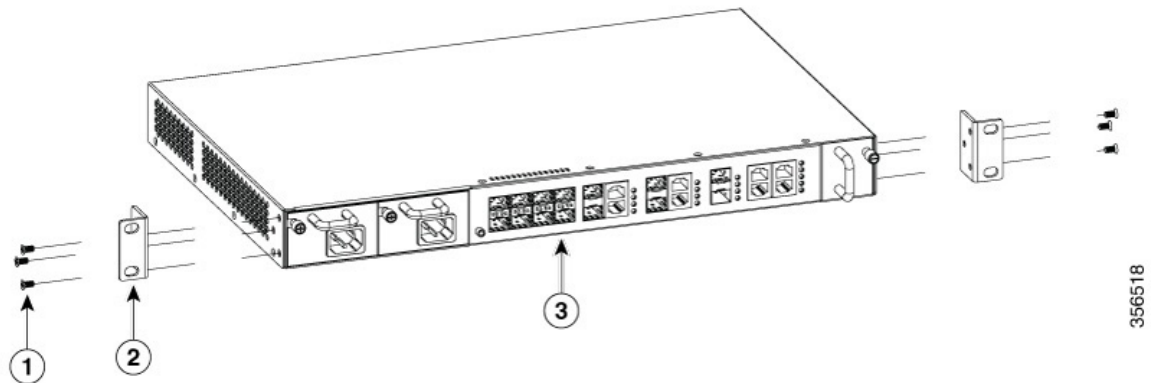
Before you begin

You should have the 19-inch rack-mounting bracket that is included with the shipping box.

Procedure

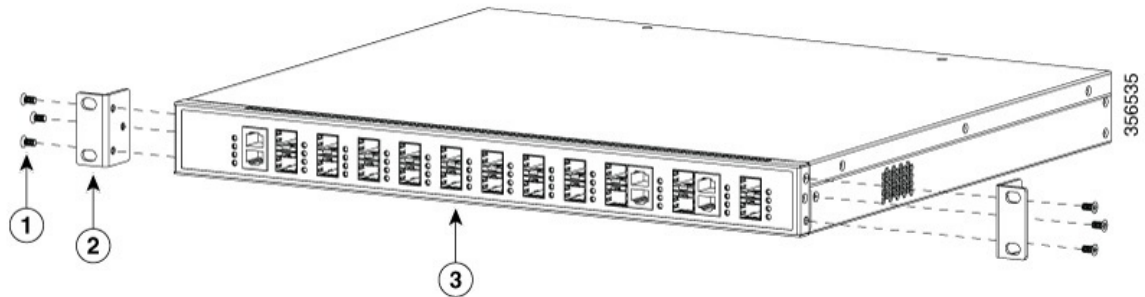
Step 1 Use the Phillips head screwdriver and attach the 19-inch rack-mounting bracket to an OLT using the mounting-bracket screws. Follow the same steps to attach the second bracket to the other side.

Figure 12: Attaching Rack-Mounting Brackets on a CGP-OLT-8T



1	6xMounting-bracket screw	3	Front-mounting position
2	2xRack-mounting bracket		

Figure 13: Attaching the Rack-Mounting Brackets on a CGP-OLT-16T



1	6xMounting-bracket screws	3	Front-mounting position
2	2xRack-mounting brackets		

Step 2 Insert the OLT into the rack and align the brackets in the rack. Use the rack-mounting screws to secure the OLT to the rack.

Warning To prevent airflow restriction, allow clearance around the ventilation openings to be at least: 3 in. (7.6 cm) **Statement 1076**

Installing SFP or SFP+ Modules

Each Cisco module has an internal serial electrically erasable programmable read-only memory (EEPROM) that is encoded with security information. This encoding provides a way for Cisco to identify and validate that the module meets the requirements for the switch.

For information about installing, removing, cabling, and troubleshooting SFP modules, see the module documentation that is shipped along with your device.

Installing an SFP or SFP+ Module

Before you begin

When installing SFP or SFP+ modules, observe these guidelines:

- Do not remove the dust plugs from the modules or the rubber caps from the fiber-optic cable until you are ready to connect the cable. The plugs and caps protect the module ports and cables from contamination and ambient light.
- To prevent ESD damage, follow your normal board and component handling procedures when connecting cables to the devices.



Caution Removing and installing an SFP or SFP+ module can shorten its useful life. Do not remove and insert any module more often than is necessary.

Procedure

- Step 1** Attach an ESD-preventive wrist strap to your wrist and the other end to a bare metal surface.
- Step 2** Find the send (TX) and receive (RX) markings on the module top.
- Note** On some SFP or SFP+ modules, the send and receive (TX and RX) markings might be replaced by arrows that show the direction of the connection.
- Step 3** If the module has a bale-clasp latch, move it to the open, unlocked position.
- Step 4** Align the module in front of the slot opening, and push until you feel the connector snapping into place.
- Step 5** Close the module's bale-clasp latch.
- Step 6** Connect the SFP cables to the modules.
- Step 7** Store the dust plugs in a safe location.
-

Removing an SFP or SFP+ Module

Procedure

- Step 1** Attach an ESD-preventive wrist strap to your wrist and the other end to a bare metal surface.
- Step 2** Disconnect the cable from the SFP or SFP+ module. For purposes of reattachment, note which cable connector plug is send (TX) and which is receive (RX).
- Step 3** Insert the dust plugs into the optical ports of the SFP or SFP+ module to keep the optical interfaces clean.
- Step 4** If the module has a bale-clasp latch, pull the bale out and down to eject it from the module. If the latch is obstructed and you cannot use your finger, use a small flat-blade screwdriver or any other long and narrow instrument to open the latch.
- Step 5** Grasp the SFP or SFP+ module, and carefully remove it from the module slot.
- Step 6** Place the module in an antistatic bag or any other protective environment.
-

Establishing the System Ground

This section describes how to connect a system ground to the OLT.



- Caution** Installations that rely solely on system grounding using only an AC third-prong ground, run a substantially greater risk of equipment problems and data corruption than those installations that use both the AC third-prong ground and a properly installed system ground.
-

The system ground provides additional grounding for EMI shielding requirements and grounding for the low voltage supplies (DC-DC converters) on the modules. You must observe the following system grounding guidelines for your chassis:

- You must install the system ground connection with any other rack or system power ground connections that you make. The system ground connection is required if FXS modules are installed or if this equipment is installed in a U.S. or European Central Office.
- You must connect both the system ground connection and the power supply ground connection to an earth ground. The system ground connection is required if FXS modules are installed or if this equipment is installed in a U.S. or European Central Office.
- When using DC-input power supplies, you must install the system (ground before you attach the source DC power cables to the DC PEM. Power down the chassis before attaching the system ground.



Note In all situations, grounding practices must comply with Section 250 of the National Electric Code (NEC) requirements or local laws and regulations. We recommend a 6-AWG grounding wire from the chassis to the rack ground or directly to the common bonding network (CBN). The equipment rack should also be connected to the CBN with a 6-AWG grounding wire.

The system ground serves as the primary safety ground for chassis that is equipped with DC-input power supplies. The DC-input power supplies for these chassis do not have a separate ground.

Required Tools and Equipment

To connect the system ground, you need the following tools and materials:

- Grounding lug: When using the double-hole lug connector provided with the system, the ground wire must be 6-AWG only. Otherwise, a supported closed-loop ring connector must be used for 8-AWG to 14-AWG wire.
- Grounding screws: One M4 x 8 mm (metric) pan-head screws. Supplied as part of the accessory kit.
- Grounding wire: Not supplied as part of the accessory kit. The grounding wire should be sized according to local and national installation requirements. For U.S. installations, AC power supply systems require a 14-AWG copper conductor. We recommend a commercially available 8-AWG to 14-AWG wire. The length of the grounding wire depends on the proximity of the switch to proper grounding facilities.
- No. 1 Phillips screwdriver.
- Crimping tool to crimp the grounding wire to the grounding lug.
- Wire-stripping tool to remove the insulation from the grounding wire.

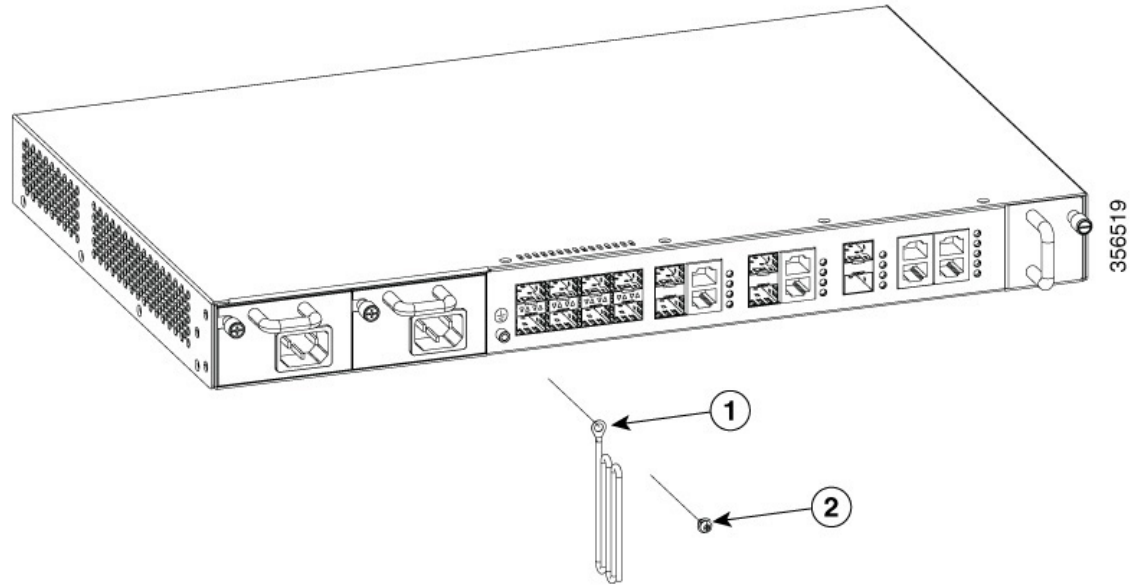
Connecting the System Ground

To establish an earth ground for the chassis, you must attach a grounding cable from the OLT grounding lug to the rack.

Procedure

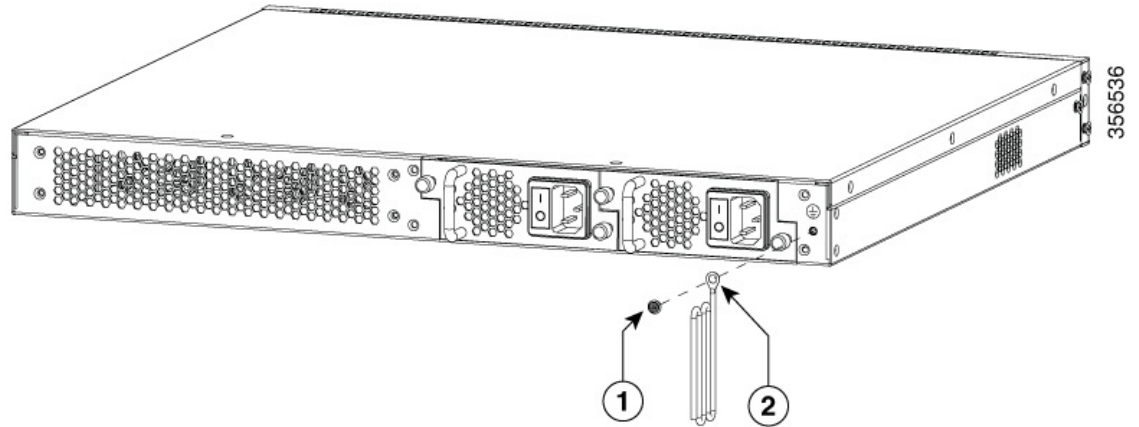
- Step 1** Secure the grounding lug to the OLT with an M4 screw. Ensure that the grounding lug and the grounding wire do not interfere with other hardware or rack equipment.

Figure 14: Connecting the System Ground for CGP-OLT-8T



1	Grounding wire with grounding lug	2	1xM4 screw
---	-----------------------------------	---	------------

Figure 15: Connecting the System Ground for CGP-OLT-16T



1	1xM4 screw	2	Grounding wire with grounding lug
---	------------	---	-----------------------------------

Step 2 Prepare the other end of the grounding wire with a ring lug, and secure it to the rack with a screw.

Connecting to the Power Source

Each power cable is shipped with mating connectors, with one of the connectors on the power socket and the other connector on the front panel of the power supply. The steps to install the AC-input and DC-input power supplies is the same, but you must ground them as explained below:

- AC-input power supply: The device is automatically grounded when you connect its power cable to the power supply and the power source.
- DC-input power supply: You must not connect the power supply directly to the earth ground.

Use one power cord for each power supply to connect the power supply to its power source.

Connecting to an AC Power Source



Warning Take care when connecting units to the supply circuit so that wiring is not overloaded. **Statement 1018**

Before you begin

Prior to connecting the power supply to a power source, ensure that the chassis is properly grounded.

Procedure

Step 1 Plug the power cable into the power connector on the power supply unit of the OLT.

Figure 16: Connecting an AC Power Cable to CGP-OLT-8T

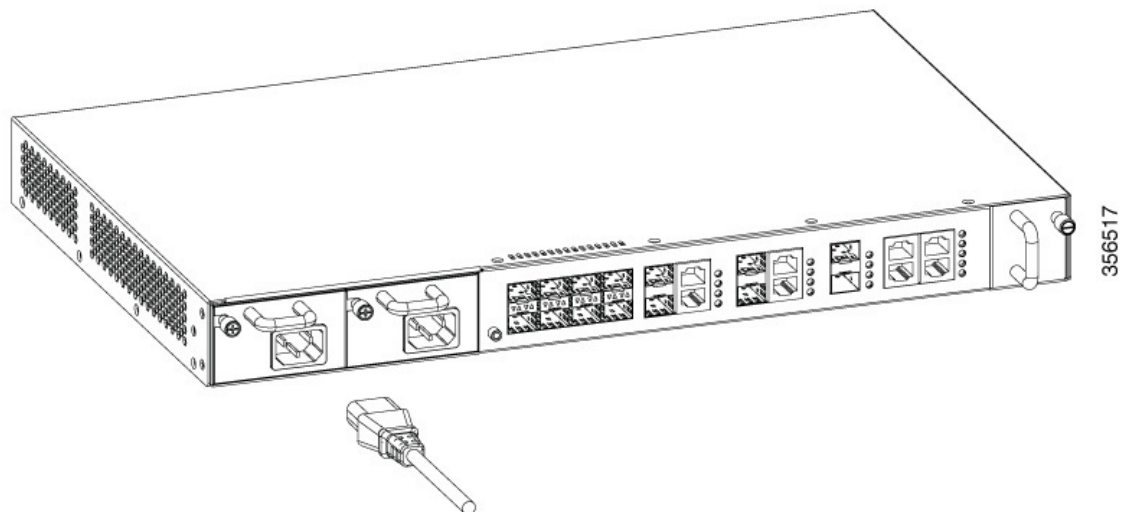
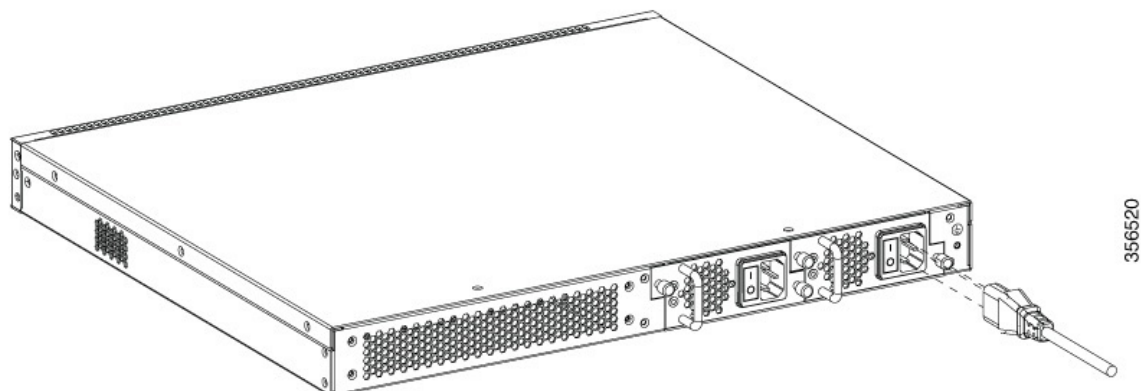


Figure 17: Connecting an AC Power Cable to CGP-OLT-16T



- Step 2** Plug the other end of the power cable into a power source.
- Step 3** Verify that the power supply is receiving power by checking whether the PWR1 or PWR2 LED is green.
- Note** If the LED does not turn on, check the power connections on the power supply and the power source.
- Step 4** The OLT will automatically boot. The RUN LED keeps blinking green after the boot is completed.

Connecting to a DC Power Source

To connect the DC power supply directly to one or two DC power sources, follow these steps:



Warning Before performing any of the following procedures, ensure that power is removed from the DC circuit. **Statement 1003**



Warning Hazardous voltage or energy may be present on DC power terminals. Always replace cover when terminals are not in service. Be sure that the uninsulated conductors are not accessible when cover is in place. **Statement 1075**

Before you begin

Prior to connecting the power supply to a power source, ensure that the chassis is properly grounded.

Procedure

- Step 1** Plug the DC power cable into the DC power supply.
- Step 2** Turn off the power at the circuit breakers for the portions of the DC grid power that you are connecting to, and verify that all the LEDs on the DC grid power supplies are off.

- Step 3** Loosen and unscrew the two nuts on the terminal box, which has two slots for power terminals. Each terminal has a nut that you can use to fasten the power cable to the terminal.
- Step 4** Secure the positive (+) DC power cable lug to the RTN terminal, and the negative (–) DC power cable lug to the NEG terminal with the nuts.
- Step 5** To tighten the nuts, apply torque between 7 lbf.in (0.8Nm) and 10lbf.in (1.1 Nm) to each nut.
- Step 6** Verify that the power supply is receiving power by checking that the PWR1 LED is green.

Note If the LED does not turn on, check the power connections on the power supply and the power source.

The OLT starts automatically. The RUN LED keeps flashing green after the boot is completed.

Setting Up the OLT

Procedure

- Step 1** Connect the RJ-45 connector end of the cable to the OLT console port.
- Step 2** Connect the DB-9 adapter end to the serial port of a connected device, such as a PC.
- Step 3** Reconfigure and reboot the connected device, if required.
- Step 4** On the connected device, run the terminal emulation program such as Windows HyperTerminal.
- Step 5** Set the following connection parameters and click **OK**:
- **Connection mode:** Serial
 - **Baud rate:** 9600
 - **Data bits:** 8
 - **Parity:** None
 - **Stop bits:** 1
 - **Flow controls:** None
- Step 6** On the console of the connected device, enter the following default credentials and press **Enter**:
- **username:** admin
 - **password:** 123456
-

Installing an ONT

The following sections provide information about the various tasks that comprise the process of installing an ONT.

Placing the ONT on a Table or Shelf

Procedure

- Step 1** Locate the adhesive strip with the rubber feet in the mounting-kit envelope.
- Step 2** Attach the four rubber feet to the four circular etches on the bottom of the ONT.
- Step 3** Place the ONT on a table or shelf near an AC power source.
-

Installing the ONT on a Wall



Warning

Read the wall-mounting instructions carefully before beginning installation. Failure to use the correct hardware or to follow the correct procedures could result in a hazardous situation to people and damage to the system.

Statement 378



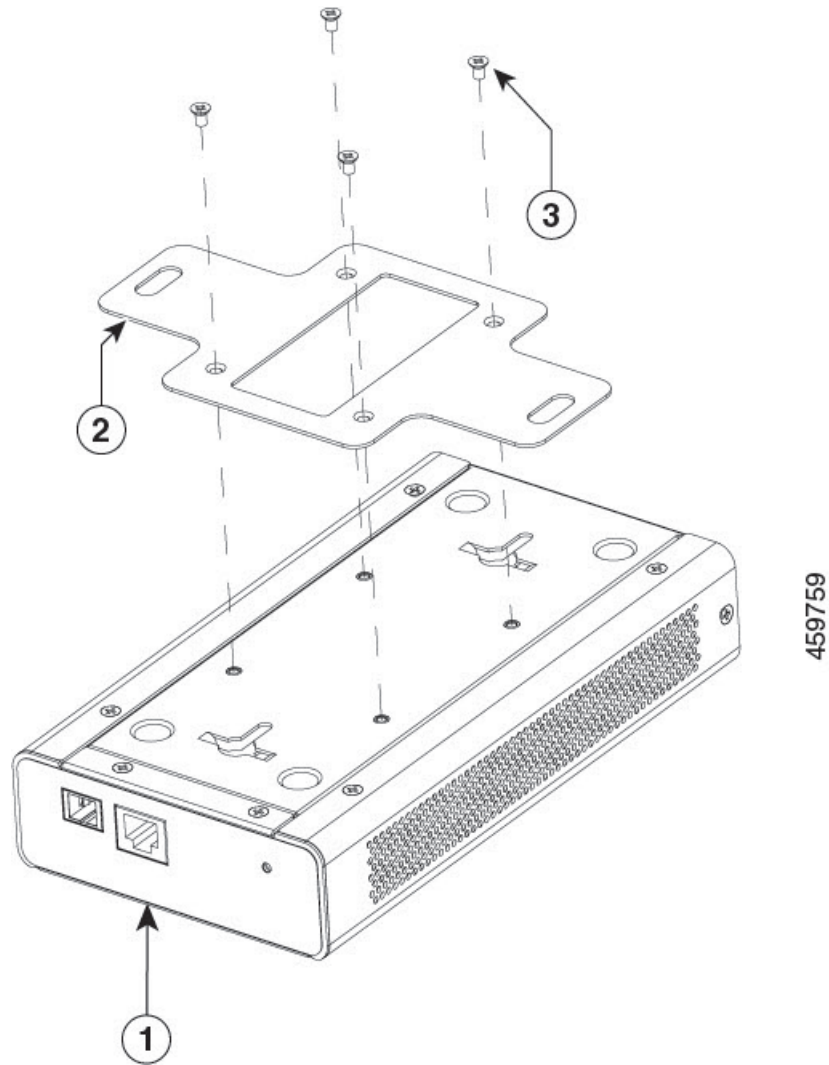
Caution

Do not wall-mount the switch with its front panel facing up. Following safety regulations, wall-mount the ONT with its front panel facing down or to the side to prevent airflow restriction and to provide easier access to the cables

Procedure

- Step 1** Determine where you want to mount the ONT. Verify that the surface is smooth, flat, dry, and sturdy.
- Step 2** Drill two pilot holes into the surface of the wall 153.20 mm apart.
- Step 3** Insert a screw into each hole, leaving a gap between the surface and the base of the screw head.
- Step 4** To attach a mounting bracket to the CGP-ONT-1P, perform the following steps:
- Place the mounting bracket with the side containing the text **This side is close to the chassis** to the base of the ONT.
 - Use the Phillips head screwdriver and attach the mounting bracket to the ONT using the mounting bracket screws.

Figure 18: Attaching the Mounting Bracket to the ONT



1	CGP-ONT-1P	3	4xMounting-bracket screw
2	Mounting bracket	-	-

Step 5 Place the bottom of the ONT over the screws on the wall and slide the ONT down until the screws fit snugly into the slots.

Attaching the Rack-Mounting Bracket and Mounting an ONT on a Rack



Warning To prevent bodily injury when mounting or servicing this unit in a rack, you must take special precautions to ensure that the system remains stable. The following guidelines are provided to ensure your safety:

- This unit should be mounted at the bottom of the rack if it is the only unit in the rack.
- When mounting this unit in a partially filled rack, load the rack from the bottom to the top with the heaviest component at the bottom of the rack.
- If the rack is provided with stabilizing devices, install the stabilizers before mounting or servicing the unit in the rack.

Statement 1006

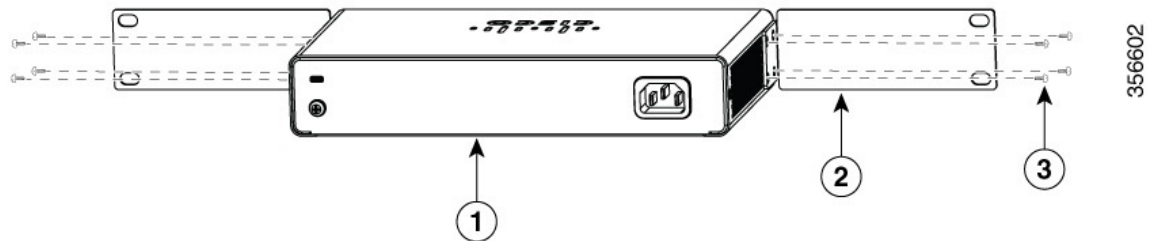
Before you begin

Make sure that you have the mounting brackets that are included with the shipping box.

Procedure

Step 1 Use the Phillips head screwdriver and attach a rack-mounting bracket to an ONT using the mounting bracket screws. Follow the same steps to attach the second bracket to the other side.

Figure 19: Attaching Rack-Mounting Brackets to a CGP-ONT-4PVC



1	8xMounting-bracket screw	3	Front-mounting position
2	2xRack-mounting bracket		

Step 2 Insert the ONT into the rack and align the bracket in the rack. Use the rack-mounting screws to secure the ONT in the rack.

Warning To prevent airflow restriction, allow clearance around the ventilation openings to be at least: 3 in. (7.6 cm). **Statement 1076**

Connecting to an AC Power Source



Warning Take care when connecting units to the supply circuit so that wiring is not overloaded. **Statement 1018**

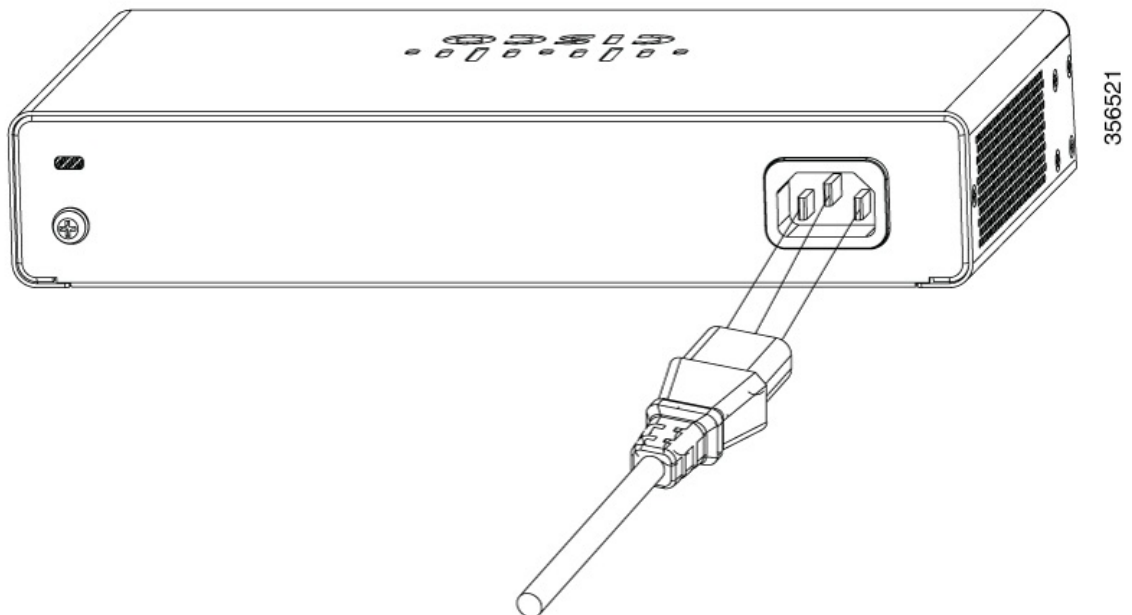
Before you begin

Prior to connecting the power supply to a power source, ensure that the ONT is properly grounded.

Procedure

Step 1 Plug the power cable into the power connector on the ONT.

Figure 20: Connecting an AC Power Cable to the CGP-ONT-4PVC



Step 2 Plug the other end of the power cable into a power source.

Step 3 Verify that the power supply is receiving power by checking whether the PWR LED is green.

Note If the LED does not turn on, check the power connections on the power supply and the power source.

Setting Up an ONT

Procedure

- Step 1** Connect a straight-through Category 5 or Category 6 Ethernet cable to a 10/100/1000 Ethernet port on the PON port of the ONT and to the Ethernet port on the PC.
- Step 2** Verify that the PC is on the same subnet as the ONT.
- The default ONT IP address is 192.168.1.1. Ping the ONT from the console of the PC:
- ```
C:\Users\Cisco>ping 192.168.1.1
Pinging 192.168.1.1 with 32 bytes of data:
Reply from 192.168.1.1: bytes=32 time=2ms TTL=64
Reply from 192.168.1.1: bytes=32 time=2ms TTL=64
Reply from 192.168.1.1: bytes=32 time=2ms TTL=64
Reply from 192.168.1.1: bytes=32 time=3ms TTL=64
Ping statistics for 192.168.1.1:
 Packets: Sent = 4, Received = 4, Lost = 0 (0% loss),
 Approximate round trip times in milli-seconds:
 Minimum = 2ms, Maximum = 3ms, Average = 2ms
```
- Step 3** To log in to the device using an internet browser on your PC, enter the IP address 192.168.1.1 in the address bar of your internet browser and press **Enter**.
- Step 4** Enter the following default credentials, and press **Enter**:
- **username:** cisco
  - **password:** cisco
- 

## Installing Cisco Catalyst PON Manager

### Before you begin

To avoid software conflicts during the installation of Cisco Catalyst PON Manager, turn off all the antivirus applications on your device.

### Procedure

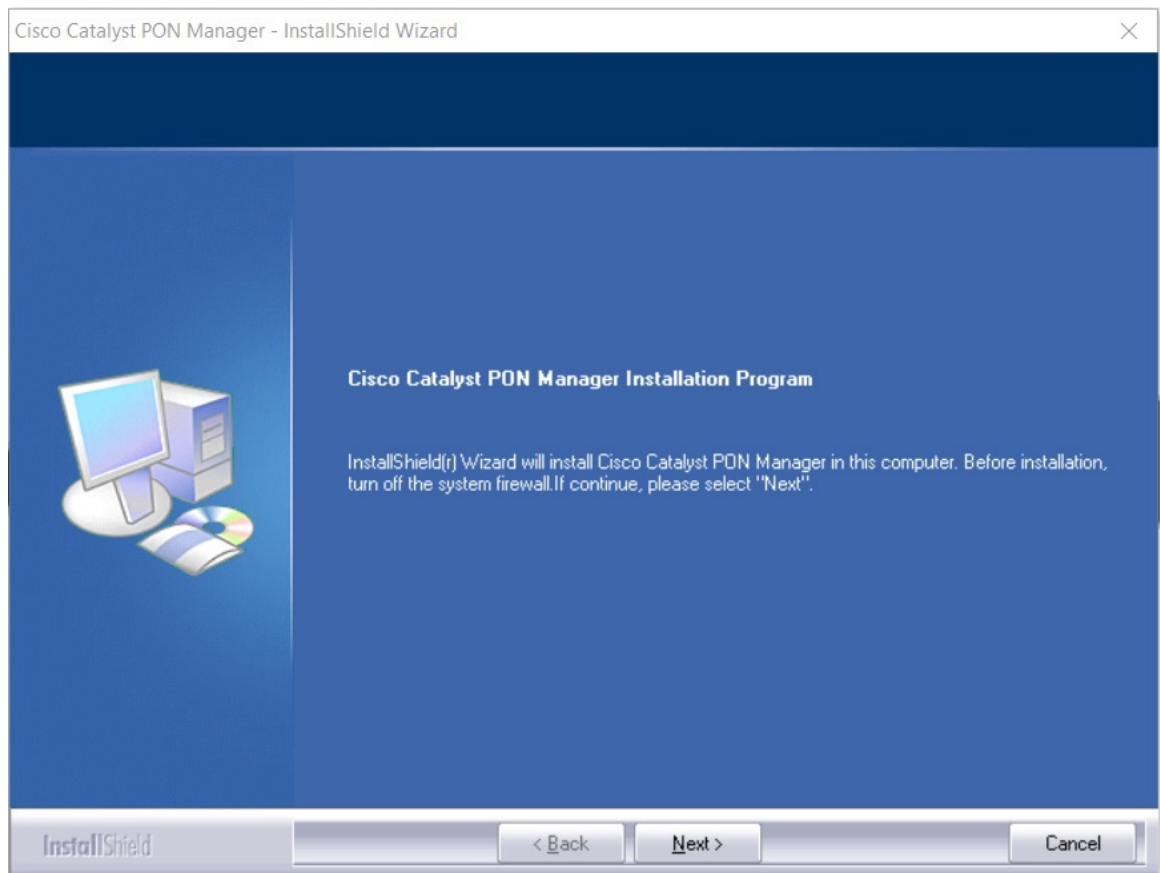
---

- Step 1** Obtain the network management software installation package from Cisco.
- Step 2** Double-click the installation package to enter the installation interface.



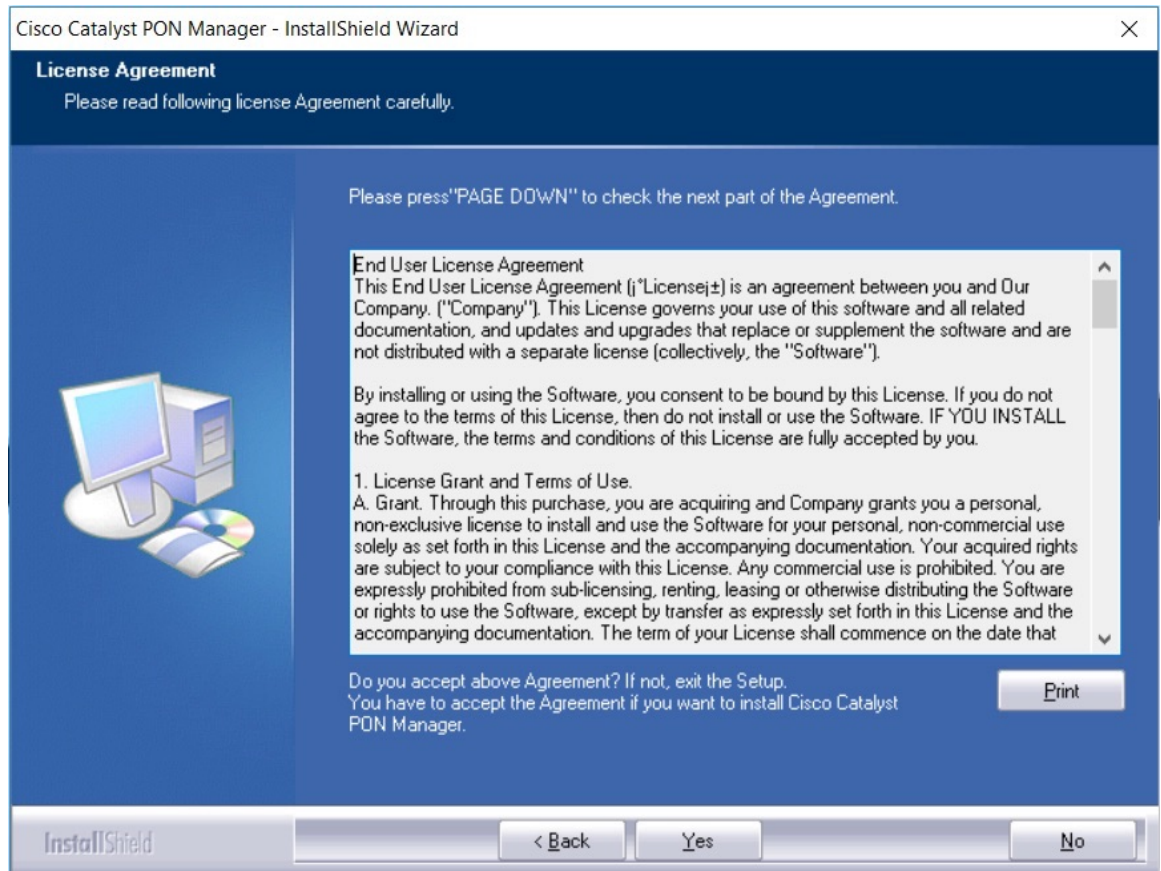
The installation wizard window is displayed.

**Step 3** Click **Next** to begin the installation.



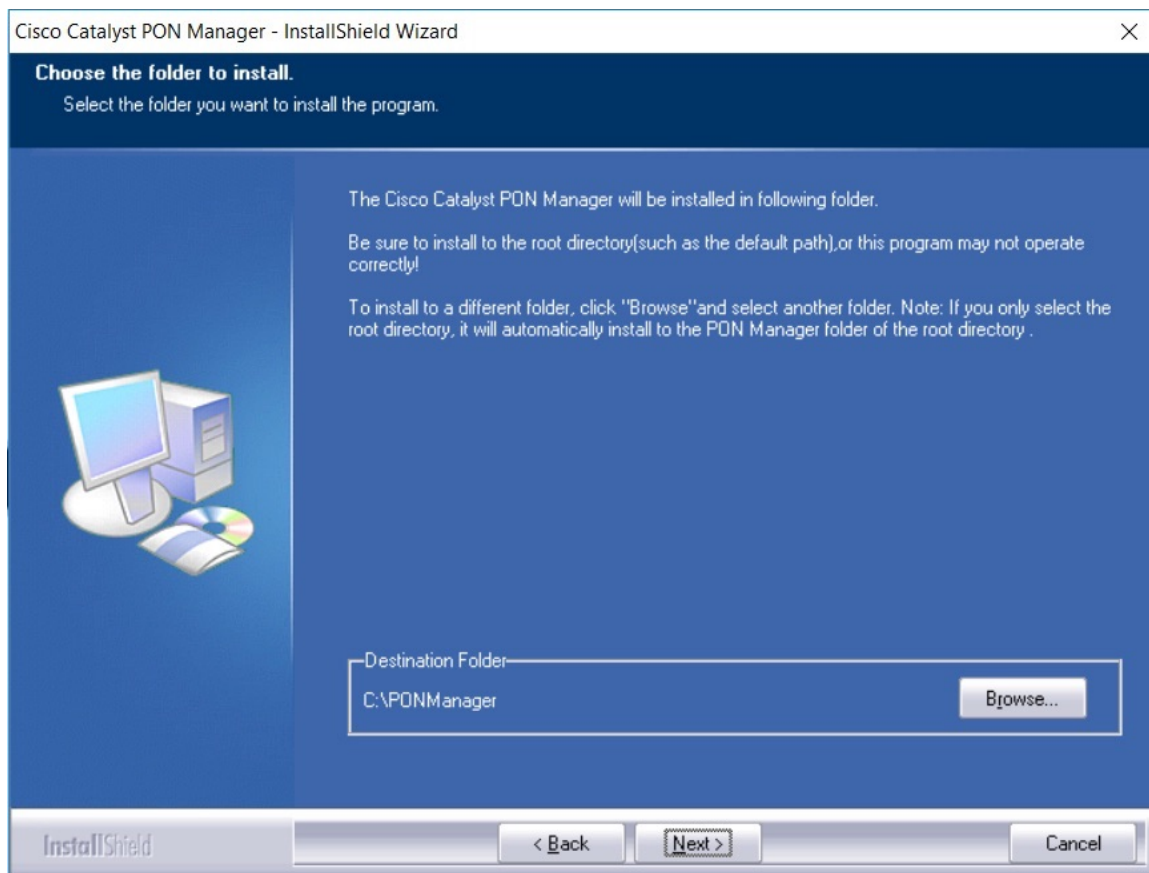
The **License Agreement** page is displayed.

**Step 4** Click **Yes** to accept the end user license agreement and continue with the installation. Click **Print** to print the agreement.



The **Choose the folder to install** page is displayed.

**Step 5** Click **Browse** to change the folder location. Click **Next** to continue with the installation.

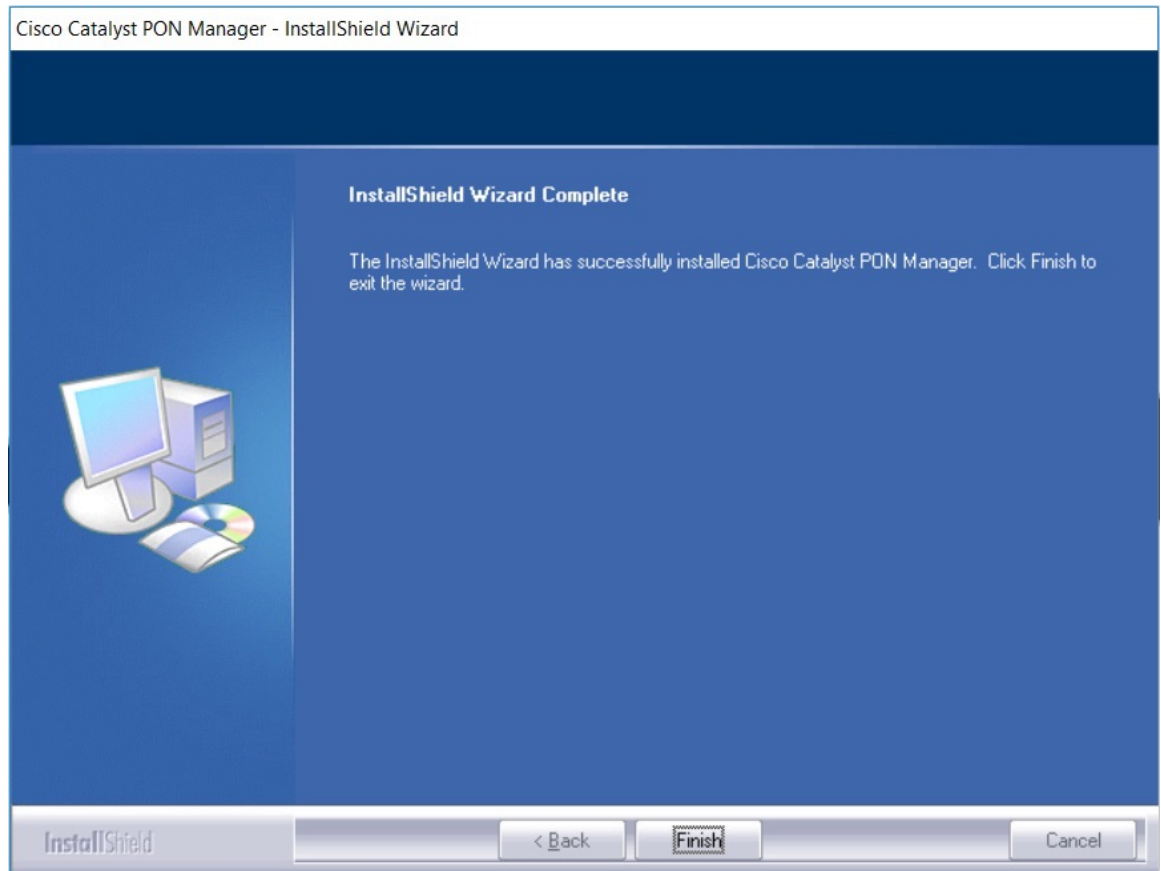


The **Select Features** page is displayed.

**Step 6** Click **Next** to start the installation.

If the installation is successful, the installation complete page is displayed.





**Step 7** Click **Finish** to complete the installation.

The server and client shortcut icons are created on the desktop.



## Setting Up Cisco Catalyst PON Manager

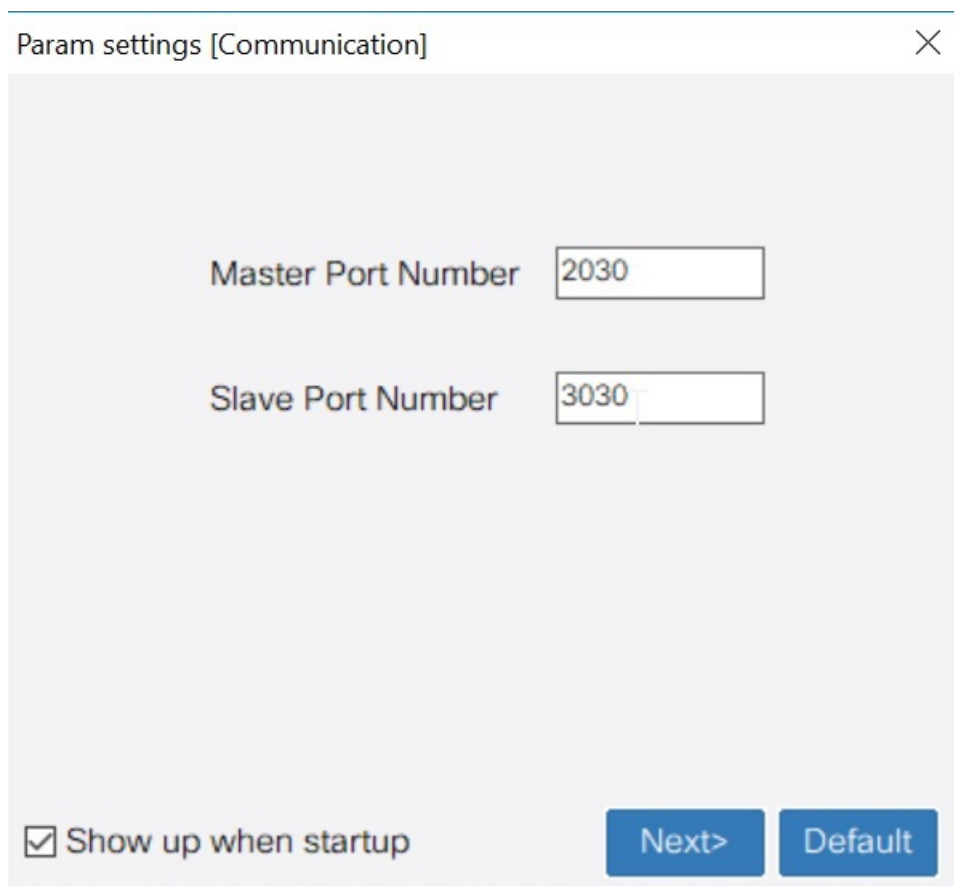
To set up Cisco Catalyst PON Manager, you need to start the PON Manager Server and then create a new user name and password in the PON Manager Client.

### Starting PON Manager Server

#### Procedure

- Step 1** Double-click on the PON Manager Server icon, if installed on the desktop or click the Windows Start button and navigate to **Cisco Catalyst PON Manager > PON Manager Server**.

The PON Manager Server settings window is displayed.



Param settings [Communication] X

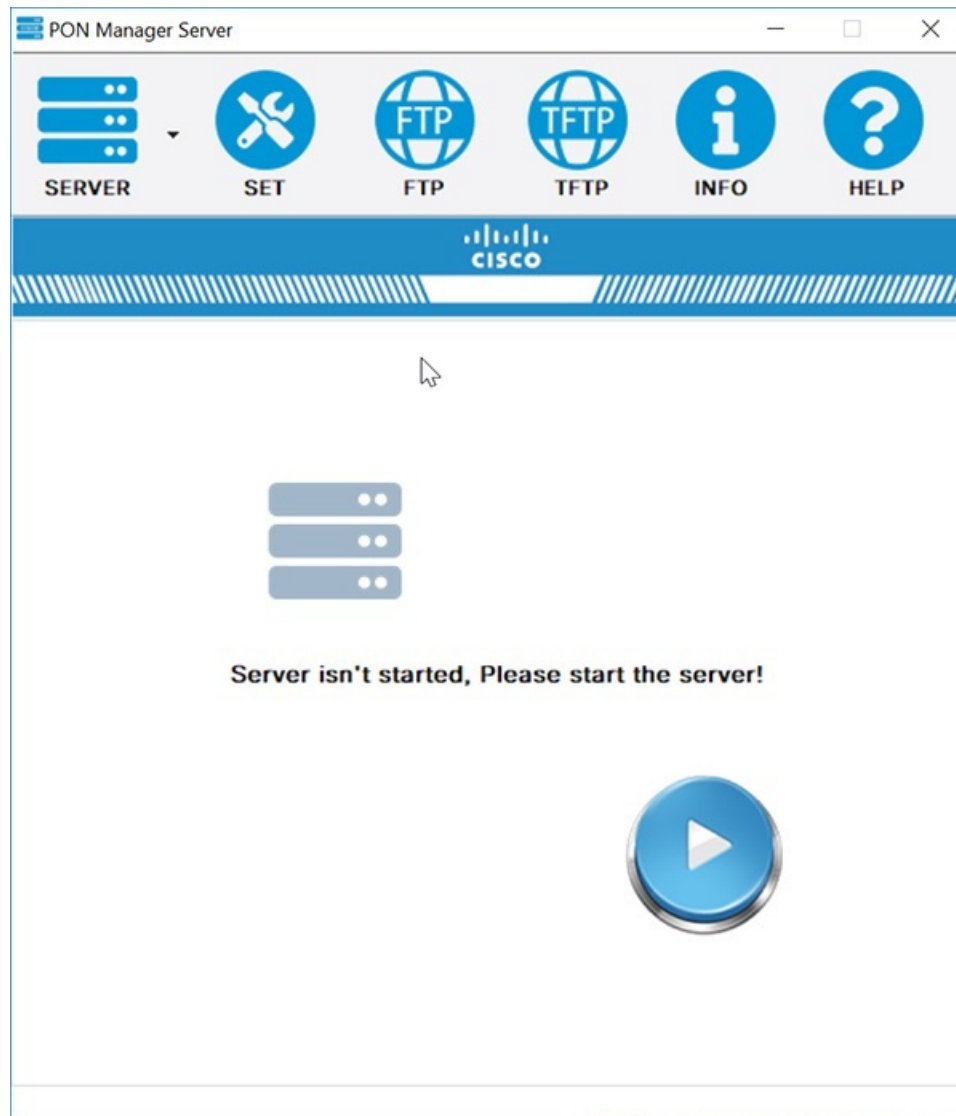
Master Port Number 2030

Slave Port Number 3030

Show up when startup

Next> Default

- Step 2** Continue clicking **Next** till the PON Manager Server home page is displayed.



**Step 3** Click the start button to start the PON Manager server.

## Creating a New User in PON Manager Client

### Procedure

**Step 1** Double-click on the PON Manager Client icon, if installed on the desktop or click the Windows Start button and navigate to **Cisco Catalyst PON Manager > PON Manager Client**.

The login page is displayed.



localhost

2030

cisco

Password

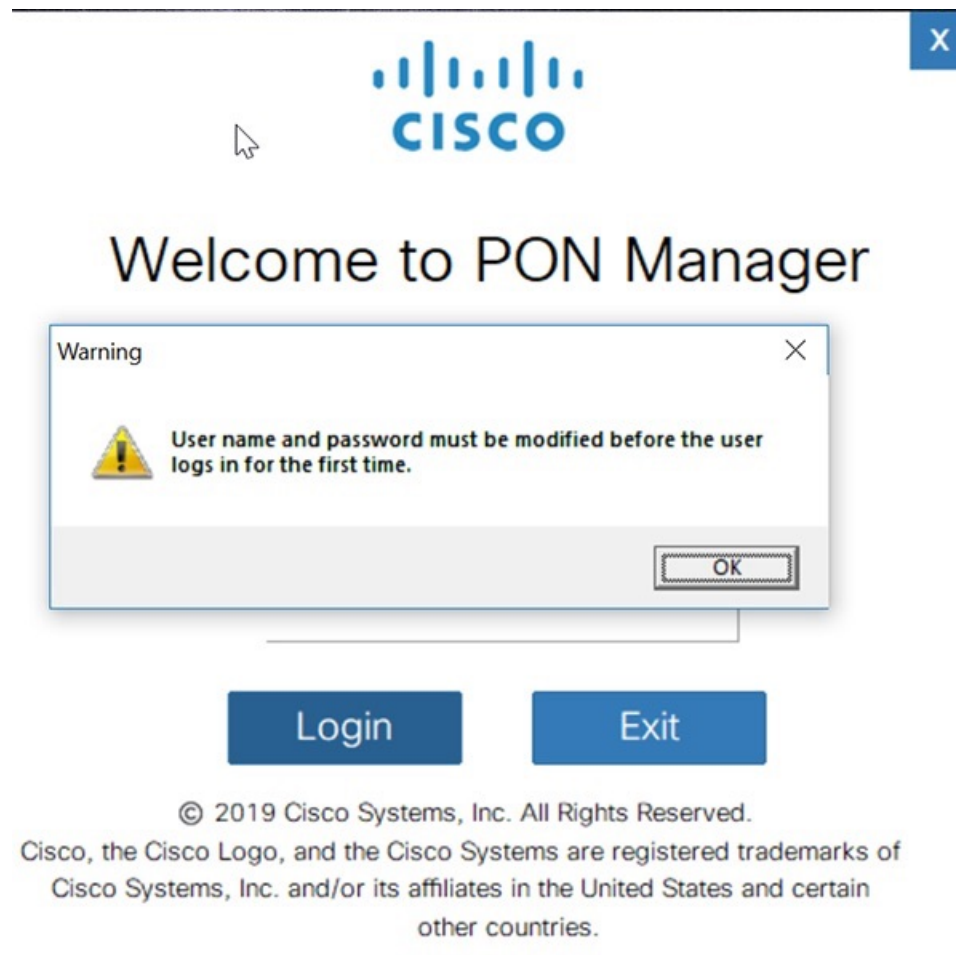
Login Exit

© 2019 Cisco Systems, Inc. All Rights Reserved.  
Cisco, the Cisco Logo, and the Cisco Systems are registered trademarks of  
Cisco Systems, Inc. and/or its affiliates in the United States and certain  
other countries.

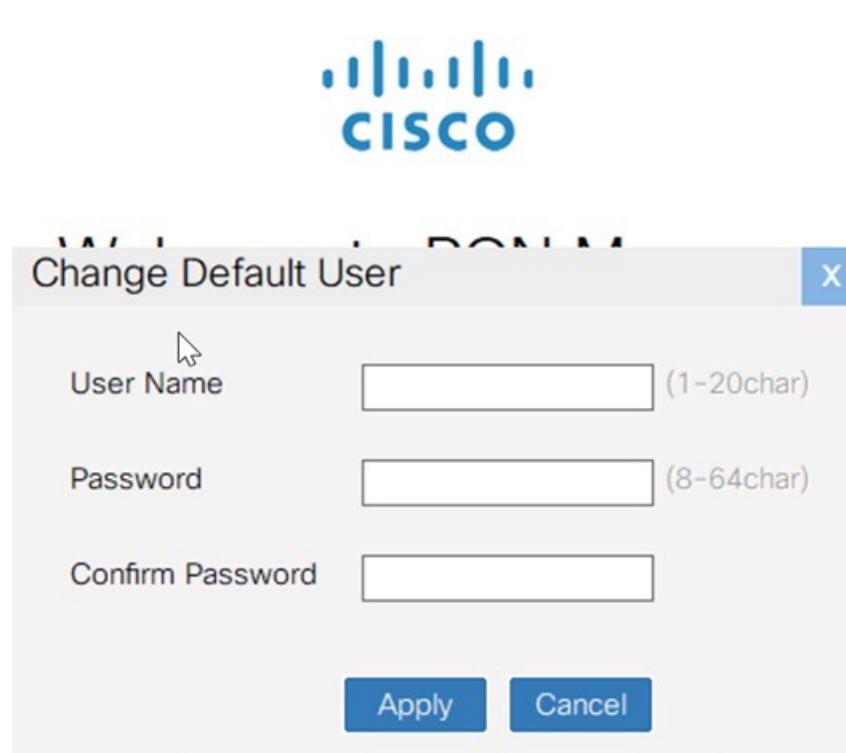
**Step 2** In the **Password** field, enter the default password as cisco.

**Step 3** Click **Login**.

A pop-up message is displayed asking you to change the user name and password.



- Step 4** Click **OK** to continue.  
The **Change Default User** dialog box is displayed.



Change Default User

User Name  (1-20char)

Password  (8-64char)

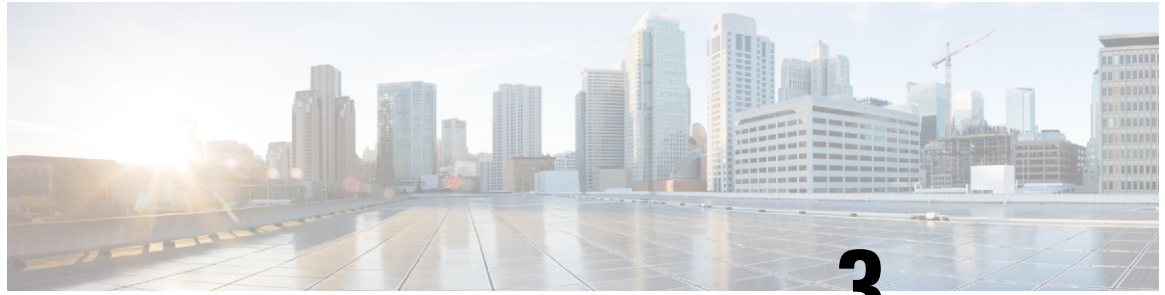
Confirm Password

Apply Cancel

© 2019 Cisco Systems, Inc. All Rights Reserved.

Cisco, the Cisco Logo, and the Cisco Systems are registered trademarks of Cisco Systems, Inc. and/or its affiliates in the United States and certain other countries.

- Step 5** In the **User Name** field, enter the new user name.  
The allowed character range is from 1 to 20.
- Step 6** In the **Password** field, enter the new password.  
The allowed character range is from 8 to 64.
- Step 7** In the **Confirm Password** field, reenter the new password.
- Step 8** To save the changes, click **Apply**.  
A confirmation message is displayed.
- Step 9** Click **OK**.  
The login page is displayed.



## CHAPTER 3

# Remove and Replace Field-Replaceable Units

- [Removing and Replacing a Fan Module, on page 45](#)
- [Removing and Replacing the Power Supply Module, on page 47](#)

## Removing and Replacing a Fan Module

The fan module can be removed and replaced only on a CGP-OLT-8T.

### Installation Guidelines

Observe these guidelines when removing or installing a fan module:

- Do not force the fan module into the slot. This can damage the pins on the device if they are not aligned with the module.
- A fan module that is only partially connected to the device can disrupt the system operation.
- The device supports hot swapping of the fan module. You can remove and replace the module without interrupting normal device operation.



#### Warning

Only trained and qualified personnel should be allowed to install, replace, or service this equipment. **Statement 1030**

## Removing the Fan Module

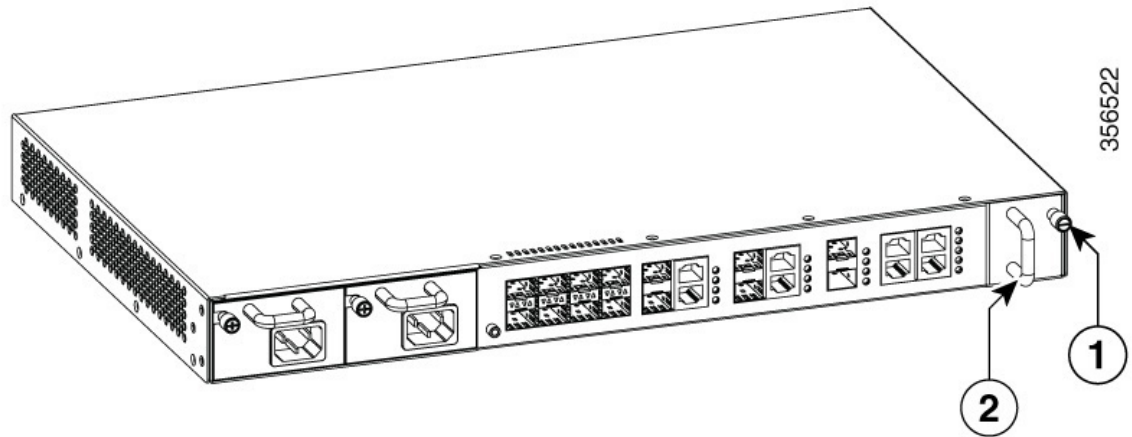
### Before you begin

- See [Installation Guidelines](#).
- Ensure that you have the following tools and accessories available:
  - Phillips head screwdriver
  - Antistatic mat

## Procedure

**Step 1** Use the Phillips head screwdriver and loosen the captive installation screw on the fan module of the OLT.

*Figure 21: Detaching the Fan Module from the CGP-OLT-8T*

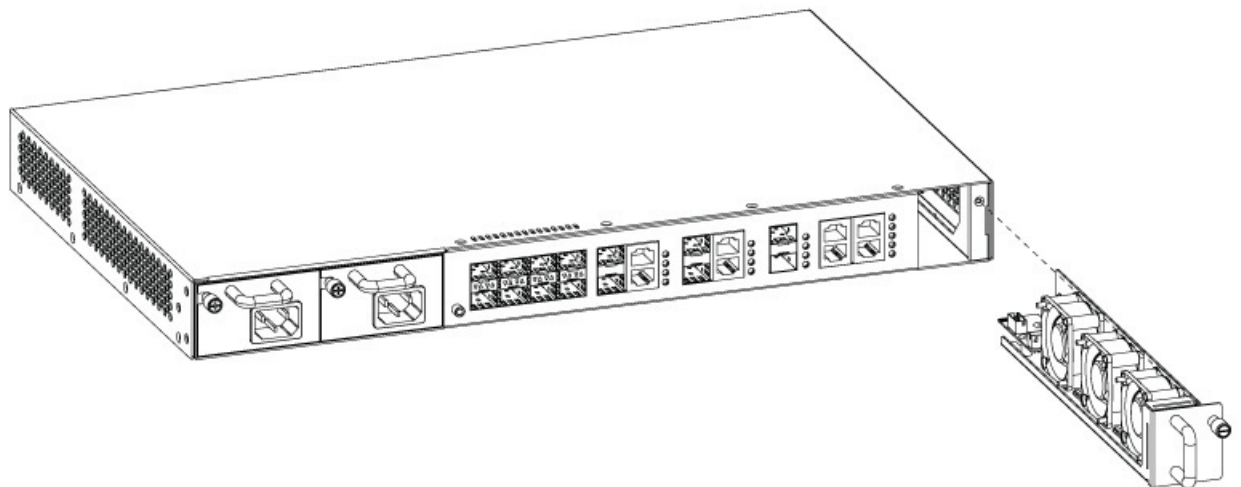


|   |                                                           |   |                                                  |
|---|-----------------------------------------------------------|---|--------------------------------------------------|
| 1 | Captive installation screw on the front of the fan module | 2 | Fan module handle on the front of the fan module |
|---|-----------------------------------------------------------|---|--------------------------------------------------|

**Step 2** Grasp the fan module handle and slide the fan module half-way out of the bay. Gently move it from side to side, if necessary, to unseat it from the OLT.

**Step 3** Place your other hand underneath to support the bottom of the fan module and then remove the fan module completely.

*Figure 22: Removing the Fan Module from the CGP-OLT-8T*





**What to do next**

Set the removed fan module aside and proceed with the task of installing the replacement or spare fan module.

## Installing a Fan Module

**Before you begin**

See [Removing the Fan Module](#).

**Procedure**

- 
- Step 1** Remove the replacement fan module from the shipping packaging.
- Step 2** Install the fan module in the fan slot by firmly pushing it into the slot and applying pressure to the end of the module and not the extraction handles.
- Warning** Do not reach into a vacant slot when installing or removing a module. Exposed circuitry is an energy hazard. **Statement 206**
- Step 3** Insert the captive installation screw on the front panel of the fan module. Use the Phillips head screwdriver and tighten the captive installation screw on the fan module.
- 

## Removing and Replacing the Power Supply Module

The location of the power supply module depends on the type of the Cisco Catalyst PON OLT:

- Front panel of CGP-OLT-8T
- Rear panel of CGP-OLT-16T

## Installation Guidelines

- The device must be installed in a cabinet or rack that is secured to the data center.
- The power supply module must be removed from its shipping container, along with packaging, if any.
- The following additional tools and equipment are required:
  - Nut driver attachment for number 1 Phillips head screwdriver or ratchet wrench with torque capability (used only for DC-input power supplies).
  - Grounding wire: Size this wire to meet local and national installation requirements. For U.S. installations, you must use an 8-AWG to 14-AWG copper conductor for AC power supply systems. For installations outside the U.S., consult your local and national electrical codes. The length of the grounding wire depends on the proximity of the switch to the grounding facilities.
- The device must be connected to an earth ground.

- The receptacles for the power sources must be within reach of the power supply cables.
- If you are connecting to a DC power, check that you are using power cables to connect to the power supply. The wire size applies to the negative (-), and positive (+) cables that connect to negative and positive apertures on the connector. You have to procure the power cable.
- If you are installing more than one DC-input power supply, each must be protected by a dedicated circuit breaker or a fuse that is sized according to the power supply input rating and the local or national electrical code requirements.
- The power sources are rated as follows:
  - For North American AC-input installations: 16A with 110V circuits.
  - For North American DC-input installations: (-48 VDC nominal at 37 A in North America (operating range: -40.5 upto -56 VDC).
  - For international installations: Size the circuits by local and national standards.
- The power supply must be already inserted into the device.

**Caution**

Ensure that the power source is off. As an added precaution, place the appropriate safety flag and lockout devices at the source power circuit breaker, or place a piece of adhesive tape over the circuit breaker handle to prevent accidental power restoration while you are working on the circuit.

**Warning**

Before performing any of the following procedures, ensure that power is removed from the DC circuit.  
**Statement 1003**

## Removing and Installing Power Supply Blank Cover

If a power supply bay in an OLT is unused, you must cover the bay with a power supply blank cover to maintain proper airflow through the device.

### Removing a Power Supply Blank Cover

#### Procedure

- 
- Step 1** Use the Phillips head screwdriver and loosen the installation screws on the power supply module blank cover.
  - Step 2** Use both hands to remove the power supply module blank cover.
  - Step 3** Store the power supply module blank cover in a safe location for future use.
-

## Installing a Power Supply Blank Cover

### Procedure

---

- Step 1** Use one hand to hold the power supply module blank cover to the required bay and insert the screws with the other hand.
- Step 2** Use the Phillips head screwdriver to tighten the power supply module blank cover to the bay.
- 

## Removing a Power Supply Module from an OLT

### Before you begin

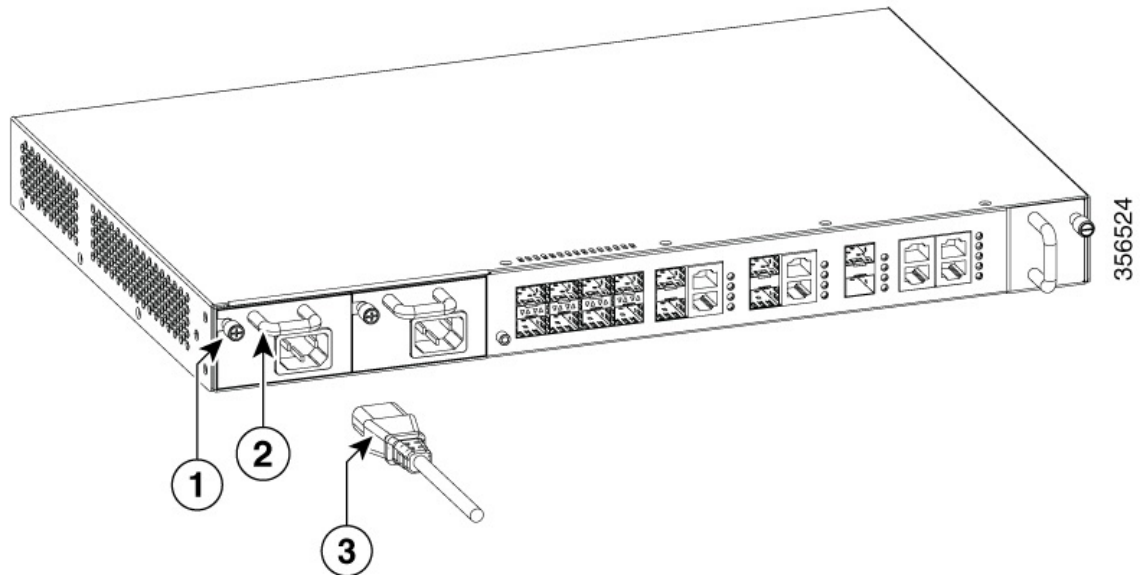
Ensure that the power is turned off at the power source by turning off the power for that circuit.

### Procedure

---

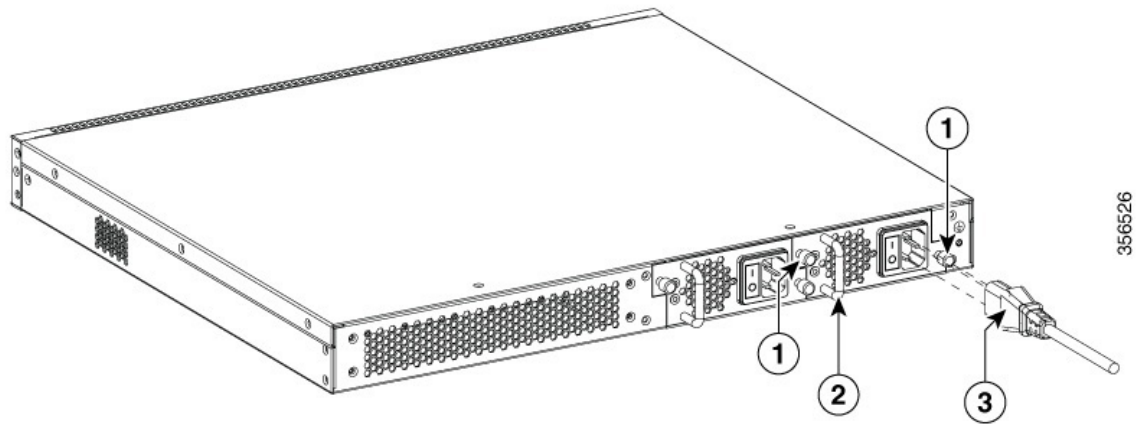
- Step 1** Detach the power and ground cables from the power source, as follows:
- For the AC-input power supply, unplug the power cables that are attached to the power supply and the power source.
  - For the DC-input power supply, remove the power cables from the power supply and the power source.
- Step 2** Remove the power cables from the OLT, as follows:
- For the AC-input power supply, unplug the power cable that is attached to the power connector to the power supply module.
  - For the DC-input power supply, loosen and unscrew the two nuts that connect the positive (+) DC power cable lug to the RTN terminal, and the negative (–) DC power cable lug to the NEG terminal. Remove the power cables from the power supply module.

Figure 23: Removing the AC Power Cable from CGP-OLT-8T



|   |                                                       |   |             |
|---|-------------------------------------------------------|---|-------------|
| 1 | Captive installation screw on the power supply module | 3 | Power cable |
| 2 | Power supply module handle on the power supply module |   |             |

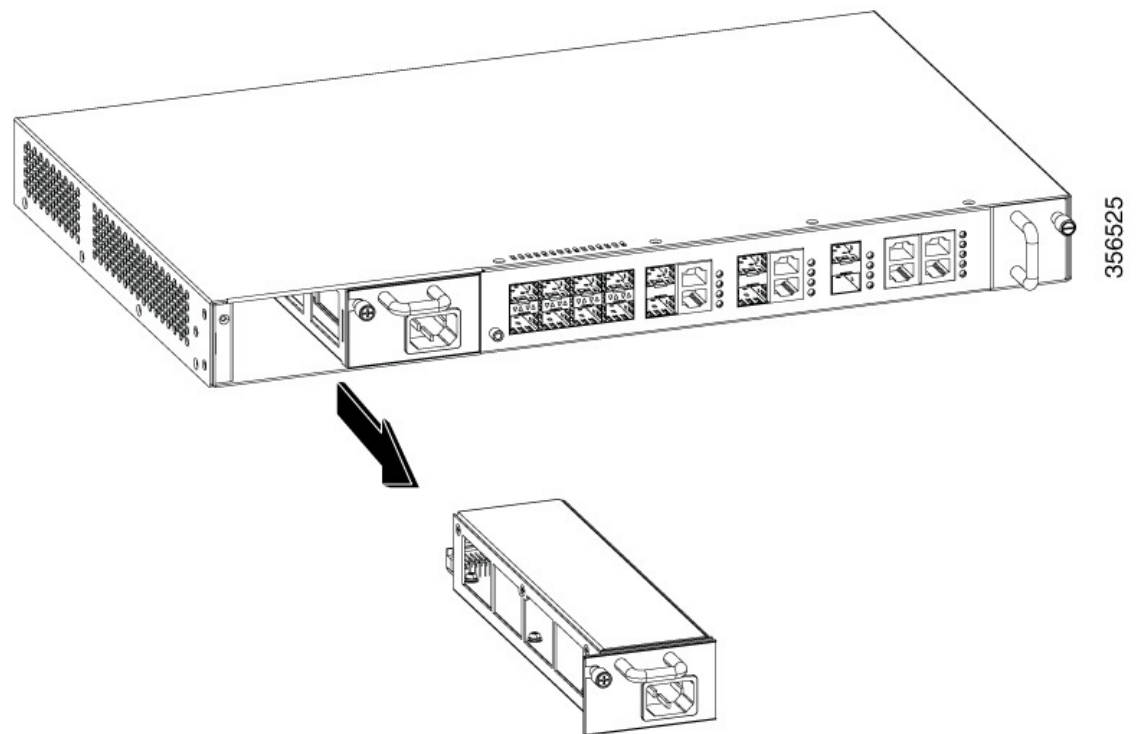
Figure 24: Removing the AC Power Cable from CGP-OLT-16T



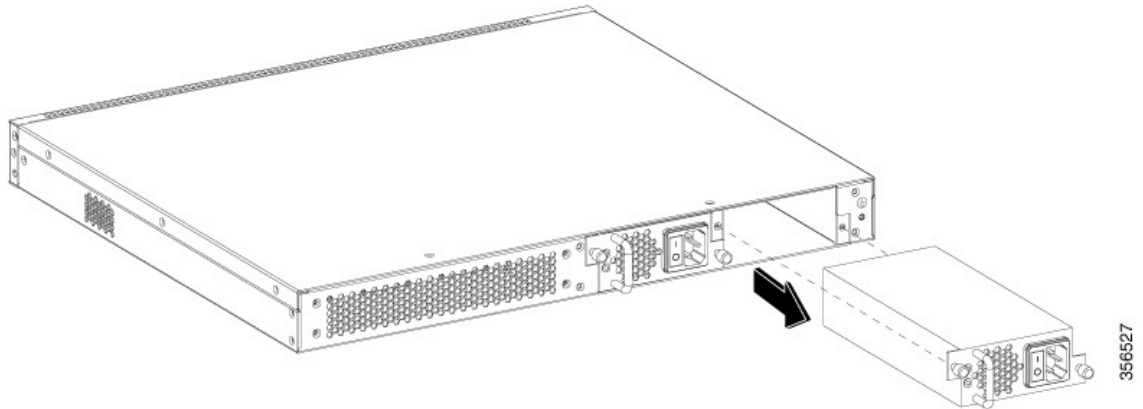
|   |                                                       |   |             |
|---|-------------------------------------------------------|---|-------------|
| 1 | Captive installation screw on the power supply module | 3 | Power cable |
| 2 | Power supply module handle on the power supply module |   |             |

- Step 3** Detach the power supply module as follows:
- On the front of CGP-OLT-8T, use the Phillips head screwdriver and loosen the captive installation screw on the power supply module.
  - On the rear of CGP-OLT-16T, use the Phillips head screwdriver and loosen the two captive installation screws on the power supply module.
- Step 4** Grasp the power supply module handle and slide the power supply module half out of the bay. Gently move it from side to side, if necessary, to unseat it from the OLT.
- Step 5** Place your other hand underneath to support the bottom of the power supply module and then remove the module completely.

**Figure 25: Removing the Power Supply Module from CGP-OLT-8T**



*Figure 26: Removing the Power Supply Module from CGP-OLT-16T*



**Caution** If you intend to operate the Cisco Catalyst PON Series OLT without installing another power supply in the empty slot, you must reinstall the blank cover over the empty power supply slot to ensure proper airflow in the system and for safety reasons.

#### What to do next

Set the removed power supply module aside and proceed with either one of the following actions:

- Install the replacement or spare power supply module.
- Install the blank cover.

## Inserting the Power Supply Module in an OLT

To insert the power supply module into the OLT, follow these steps:

#### Before you begin

- If you are installing a spare power supply module, see [Removing a Power Supply Blank Cover](#).
- If you are installing a replacement power supply module, see [Removing a Power Supply Module from an OLT](#).
- Verify that the power supply is not connected to any power sources.

#### Procedure

- Step 1** Hold the handle on the power supply module with one hand and position the power supply with its back end at the open power supply bay.
- Step 2** Slide the unit all the way into the power supply bay until the power supply module is firmly in place.

**Note** Ensure that the text on the power supply module is facing up while inserting the power supply module. The antireverse structure of the power supply module prevents you from inserting it in the reverse direction.

**Step 3** Secure the power supply module as follows:

- On the front of CGP-OLT-8T, use the Phillips head screwdriver and tighten the captive installation screws on the power supply module to the power supply bay.
- On the rear of CGP-OLT-16T, use the Phillips head screwdriver and tighten the two captive installation screws on the power supply module to the power supply bay.

---

### What to do next

You can proceed with either of the following actions:

- Connect an AC power source, see [Connecting to an AC Power Source](#).
- Connect a DC power source, see [Connecting to a DC Power Source](#).







## CHAPTER 4

# Troubleshoot

---

- [Troubleshooting Common Issues, on page 55](#)
- [Cisco Catalyst PON Series OLT Troubleshooting, on page 56](#)
- [Cisco Catalyst PON Series ONT Troubleshooting, on page 58](#)

## Troubleshooting Common Issues

The following section provide information about how to troubleshoot common issues in the Cisco Catalyst PON Series Switches.

### Bad or Damaged Cable

Always examine the cable for marginal damage or failure. A cable might appear physically good, but it could corrupt packets as a result of subtle damage to the wiring or connectors. You can identify this situation because of packet errors occurring at the port or the port constantly flapping.

Perform the following checks on the cable:

- Examine or exchange the copper or fiber-optic cable with a working cable.
- Look for broken or missing pins on cable connectors.
- Rule out any bad patch panel connections or media convertors between the source and the destination. If possible, bypass the patch panel, or eliminate faulty media convertors (fiber-optic-to-copper).
- Test the cable in another port or interface, if possible, to identify if the fault is with the cable.

### Ethernet and Fiber-Optic Cables

Make sure that you have the correct cable for the connection:

- For Ethernet, use Category 3 copper cable for 10 Mbps UTP connections. Use either Category 5, Category 5e, or Category 6 UTP for 10/100/1000 Mbps connections.
- For fiber-optic cables, verify that you have the correct cable for distance and port type. Ensure that the connected device ports match and use the same type of encoding, optical frequency, and fiber type.
- For copper connections, determine if a crossover cable was used when a straight-through was required, or the reverse. Enable auto-MDIX on the device, or replace the cable.

## Link Status

Verify that both sides have links. A single broken wire or a shutdown port can show the link that is established on one side even though the other side does not have a link.

A port LED that is in ON status does not guarantee that the cable is fully functional. The cable might have encountered physical stress that causes it to function at a marginal level. If the port LED does not turn ON, do the following:

- Connect the cable from the field device to a functioning good device.
- Ensure that both ends of the cable are connected to the correct ports.
- Verify that both devices have power.
- Verify that you are using the correct cable type.
- Check for loose connections. Disconnect the cable and reconnect it if it is not seated properly.

## 10/100/1000 PoE+ Port Connections

If a powered device that is connected to a PoE+ port does not receive power, do the following:

- Verify that the power supply installed in the OLT meets the power requirements of your connected devices.
- Verify the cable type.



---

**Caution**

Noncompliant cabling or powered devices can cause a PoE+ port fault. Use only standard or compliant cabling to connect Cisco devices. You must remove any cable or device that causes a PoE+ fault.

---

## Cisco Catalyst PON Series OLT Troubleshooting

The following sections describe how to troubleshoot issues relating to the Cisco Catalyst PON Series OLT.

### SFP and SFP+ Module

Use only Cisco SFP or SFP+ modules. Each Cisco module has an internal serial EEPROM that is encoded with security information. This encoding provides a way for Cisco to identify and validate that the module meets the requirements for the switch.

You can perform the following checks:

- Inspect the SFP module. Exchange the module with a functioning module. Verify that the module is supported on this platform.
- Use the **show interfaces** command in privileged EXEC mode to see if the port or module is error-disabled, disabled, or shut down. Reenable the port, if needed.

- Make sure that all fiber-optic connections are free of dust and impurities, and are securely connected.
- Make sure that you keep an interval of 5 seconds between inserting SFPs in multiple device ports. This prevents the ports from going into error disabled mode. Similarly, after you remove an SFP from a port, wait for 5 seconds before reinserting it.

## Fan Module

An alarm notification sent through the Cisco Catalyst PON Manager when a pluggable fan module is faulty.

Make sure you replace the fan module within the following time period:

- Replace the fan module within one week if one alarm notifications occur in the Cisco Catalyst PON Manager.
- Replace the fan module within 24 hours if two alarm notifications occur in the Cisco Catalyst PON Manager.
- Replace the fan module within 5 minutes if three alarm notifications occur in the Cisco Catalyst PON Manager.

To replace the fan module, see [Removing and Replacing a Fan Module](#).

## Power Supply Module

The PWR1 and PWR2 LEDs indicate whether the power supply module is faulty.

For details about the LED indicators of the pluggable power supply module, see [Table 2: System LEDs, on page 6](#)

If the power supply is faulty, check the following:

- Check if the pluggable power supply module is turned on.
- Check that the power cable is properly connected.
- Check if the input power matches the power ratings of the Cisco Catalyst PON Series OLT.
- Make sure that the Cisco Catalyst PON Series OLT is operating within its permissible operating temperature. If not, move the Cisco Catalyst PON Series OLT to a location where there is proper ventilation.

## Interface Indicator

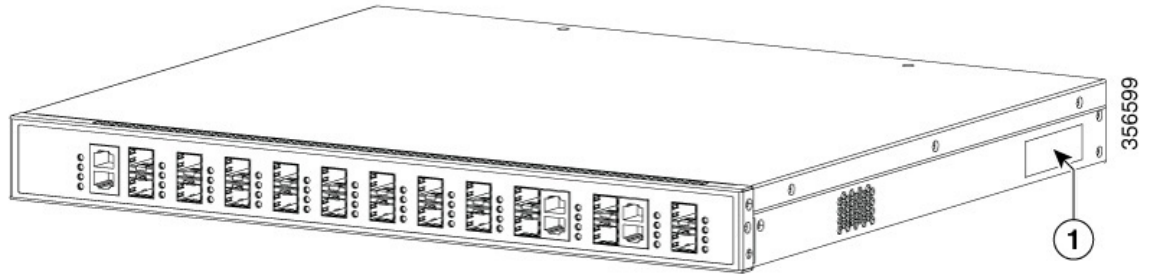
The LINK LED indicates whether the connection is faulty. If the LINK LED is not turned on, do the following:

- Check whether the fiber optic connection is reversed.
- Check whether the optical module is damaged.

## Finding a Cisco Catalyst PON OLT Serial Number

If you contact Cisco Technical Assistance, you must know the Cisco Catalyst PON OLT serial number.

Figure 27: Serial Number Location

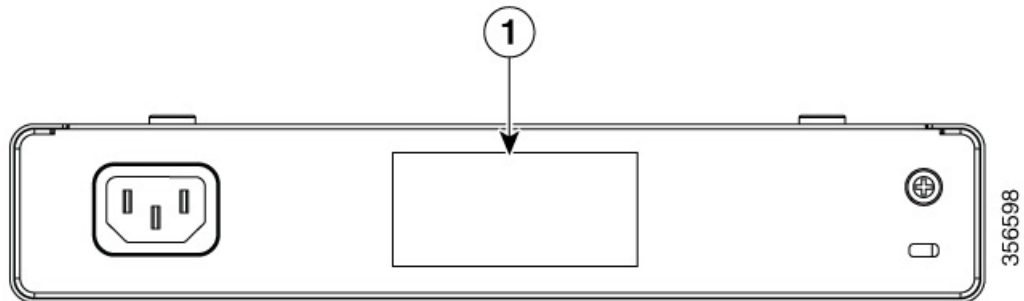


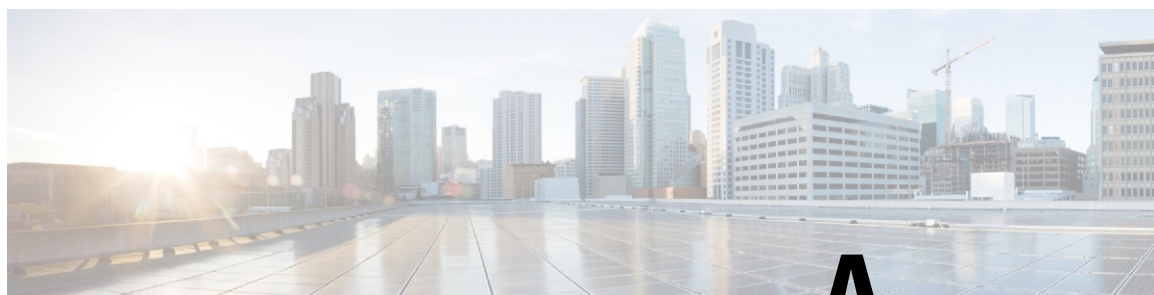
# Cisco Catalyst PON Series ONT Troubleshooting

## Finding the Cisco Catalyst PON ONT Serial Number

If you contact Cisco Technical Assistance, you must know the Cisco Catalyst PON ONT serial number.

Figure 28: Serial Number Location





# APPENDIX **A**

## Technical Specifications

- [Cisco Catalyst PON Series OLT Technical Specifications, on page 59](#)
- [Cisco Catalyst PON Series ONT Technical Specifications, on page 60](#)

## Cisco Catalyst PON Series OLT Technical Specifications

The following sections provide information about the Cisco Catalyst PON Series OLT.

### Physical Specifications

#### CGP-OLT-8T

| Physical Dimensions    |                                                |
|------------------------|------------------------------------------------|
| Weight                 | 9.92 lbs (4.5 kg)                              |
| Dimensions (H x D x W) | 1.73 x 17.3 x 10.82 in. (4.4 x 44.0 x 27.5 cm) |

#### CGP-OLT-16T

| Physical Dimensions    |                                                |
|------------------------|------------------------------------------------|
| Weight                 | 16.75 lbs (7.6 kg)                             |
| Dimensions (H x D x W) | 1.73 x 17.3 x 14.96 in. (4.4 x 44.0 x 38.0 cm) |

### Environmental Specifications

| Environmental Ranges               |                                                       |
|------------------------------------|-------------------------------------------------------|
| Operating temperature <sup>3</sup> | 23°F to 104°F (-5°C to 40°C)                          |
| Storage temperature                | -13° to 158°F (-25° to 70°C) up to 15,000 ft (4500 m) |
| Operating relative humidity        | 5% to 90% (noncondensing)                             |

| Environmental Ranges      |                           |
|---------------------------|---------------------------|
| Storage relative humidity | 5% to 95% (noncondensing) |
| Storage altitude          | Up to 15,000 ft (4500 m)  |

<sup>3</sup> Minimum ambient temperature for cold start is 32°F (0°C)

## Power Requirements

| Power Requirements |                                                             |
|--------------------|-------------------------------------------------------------|
| AC input voltage   | 110 to 220 VAC                                              |
| DC input voltage   | -36 to -72 VDC                                              |
| Power rating       | 55 W full load (CGP-OLT-8T)<br>70 W full load (CGP-OLT-16T) |

# Cisco Catalyst PON Series ONT Technical Specifications

The following sections provide information about the Cisco Catalyst PON Series ONT.

## Physical Specifications

### CGP-ONT-1P

| Physical Dimensions    |                                            |
|------------------------|--------------------------------------------|
| Weight                 | 0.8 lbs (0.36 kg)                          |
| Dimensions (H x D x W) | 1.6 x 6.6 x 6.9 in. (4.0 x 16.8 x 17.5 cm) |

### CGP-ONT-4P, CGP-ONT-4PV, and CGP-ONT-4PVC

| Physical Dimensions    |                                               |
|------------------------|-----------------------------------------------|
| Weight                 | 2.75 lbs (1.25 kg)                            |
| Dimensions (H x D x W) | 1.73 x 9.44 x 5.70 in. (4.4 x 24.0 x 14.5 cm) |

### CGP-ONT-4TVCW

| Physical Dimensions    |                                            |
|------------------------|--------------------------------------------|
| Weight                 | 2.75 lbs (1.25 kg)                         |
| Dimensions (H x D x W) | 1.6 x 6.6 x 6.9 in. (4.0 x 16.8 x 17.5 cm) |

## Environmental Specifications

| Environmental Ranges               |                                                       |
|------------------------------------|-------------------------------------------------------|
| Operating temperature <sup>4</sup> | 23°F to 104°F (-5°C to 40°C)                          |
| Storage temperature                | -13° to 158°F (-25° to 70°C) up to 15,000 ft (4500 m) |
| Operating relative humidity        | 5% to 90% (noncondensing)                             |
| Storage relative humidity          | 5% to 95% (noncondensing)                             |
| Storage altitude                   | Up to 15,000 ft (4500 m)                              |

<sup>4</sup> Minimum ambient temperature for cold start is 32°F (0°C)

## Power Requirements

| Power Requirements |                                                                                             |
|--------------------|---------------------------------------------------------------------------------------------|
| AC input voltage   | 110 to 220 VAC, 1.1 A                                                                       |
| Power rating       | 36W (CGP-ONT-1P)<br>72 W (CGP-ONT-4P, CGP-ONT-4PV, and CGP-ONT-4PVC)<br>18W (CGP-ONT-4TVCW) |







# APPENDIX **B**

## Connector and Cable Specifications

This appendix contains these topics:

- [Connector Specifications, on page 63](#)
- [Cables and Adapters, on page 64](#)

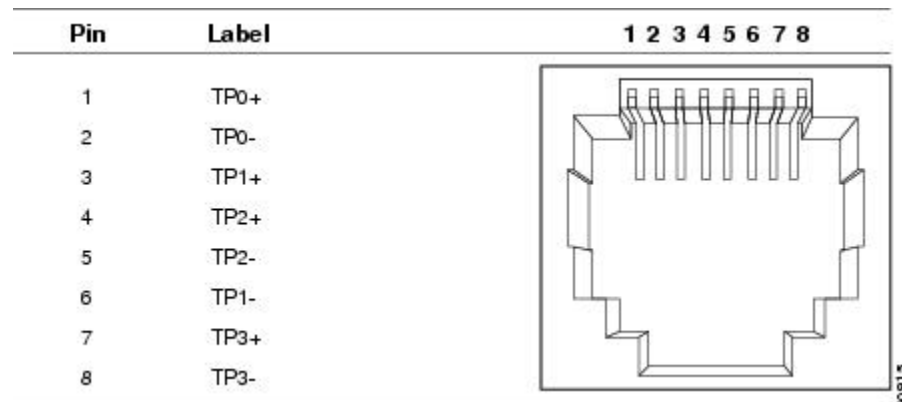
### Connector Specifications

The following sections provide information about the various connectors.

#### 10/100/1000 Ports (Including PoE)

All 10/100/1000 ports use standard RJ-45 connectors and Ethernet pinouts.

*Figure 29: 10/100/1000 Port Pinouts*



#### SFP Module Connectors

*Figure 30: Duplex LC Cable Connector*

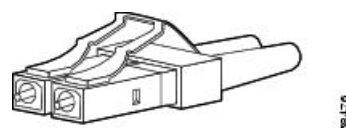


Figure 31: Simplex LC Cable Connector

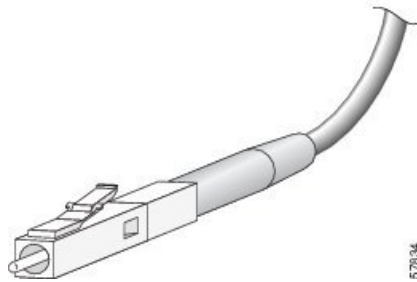


Figure 32: Copper SFP Module LC Connector

| Pin | Label | 1 | 2 | 3 | 4 | 5 | 6 | 7 | 8 |
|-----|-------|---|---|---|---|---|---|---|---|
| 1   | TP0+  |   |   |   |   |   |   |   |   |
| 2   | TP0-  |   |   |   |   |   |   |   |   |
| 3   | TP1+  |   |   |   |   |   |   |   |   |
| 4   | TP2+  |   |   |   |   |   |   |   |   |
| 5   | TP2-  |   |   |   |   |   |   |   |   |
| 6   | TP1-  |   |   |   |   |   |   |   |   |
| 7   | TP3+  |   |   |   |   |   |   |   |   |
| 8   | TP3-  |   |   |   |   |   |   |   |   |

## Cables and Adapters

The following sections provide information about the various cables and adapters.

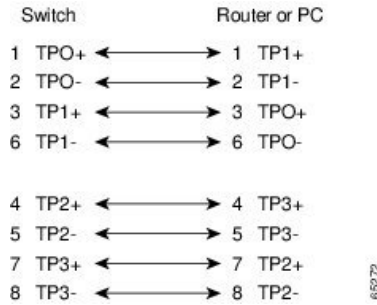
### Transceiver Module Network Cables

For cabling specifications, see [Cisco SFP and SFP+ Transceiver Module Installation Notes](#).

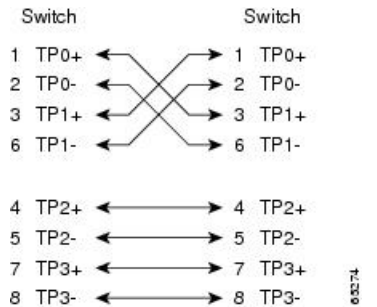
Each port must match the wavelength specifications on the other end of the cable, and the cable must not exceed the stipulated length. Copper 1000BASE-T SFP module transceivers use standard four twisted-pair, Category 5 cable of lengths up to 328 feet (100 meters).

# Cable Pinouts

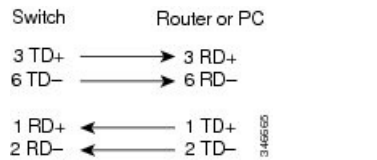
**Figure 33: Four Twisted-Pair Straight-Through Cable Schematic**



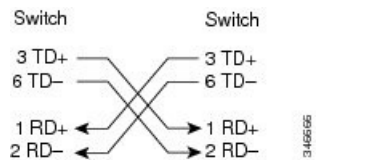
**Figure 34: Four Twisted-Pair Semi-Cross Cable Schematic**



**Figure 35: Two Twisted-Pair Straight-Through Cable Schematic**

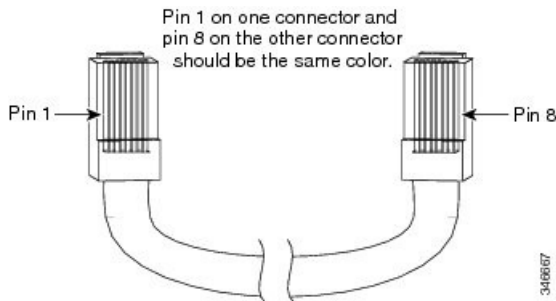


**Figure 36: Two Twisted-Pair Crossover Cable Schematic**



## Identifying a Crossover Cable

To identify a crossover cable, compare the two modular ends of the cable. Hold the cable ends side by side, with the tab at the back. The wire connected to the pin on the outside of the left plug should be a different color from the wire that is connected to the pin on the inside of the right plug.

**Figure 37: Identifying a Crossover Cable**

## Console Port Adapter Pinouts

The RS-232 console port uses an 8-pin RJ-45 connector. Use an RJ-45-to-DB-9 adapter cable to connect the switch console port to a console PC. You must provide a RJ-45-to-DB-25 female DTE adapter to connect the switch console port to a terminal.

**Table 11: Console Port Signaling with a DB-9 Adapter**

| Switch Console Port (DTE) | RJ-45-to-DB-9 Terminal Adapter | Console Device |
|---------------------------|--------------------------------|----------------|
| Signal                    | DB-9 Pin                       | Signal         |
| RTS                       | 8                              | CTS            |
| DTR                       | 6                              | DSR            |
| TxD                       | 2                              | RxD            |
| GND                       | 5                              | GND            |
| GND                       | 5                              | GND            |
| RxD                       | 3                              | TxD            |
| DSR                       | 4                              | DTR            |
| CTS                       | 7                              | RTS            |

**Table 12: Console Port Signaling with a DB-25 Adapter**

| Switch Console Port (DTE) | RJ-45-to-DB-25 Terminal Adapter | Console Device |
|---------------------------|---------------------------------|----------------|
| Signal                    | DB-25 Pin                       | Signal         |
| RTS                       | 5                               | CTS            |
| DTR                       | 6                               | DSR            |
| TxD                       | 3                               | RxD            |
| GND                       | 7                               | GND            |

| <b>Switch Console Port (DTE)</b> | <b>RJ-45-to-DB-25 Terminal Adapter</b> | <b>Console Device</b> |
|----------------------------------|----------------------------------------|-----------------------|
| <b>Signal</b>                    | <b>DB-25 Pin</b>                       | <b>Signal</b>         |
| GND                              | 7                                      | GND                   |
| RxD                              | 2                                      | TxD                   |
| DSR                              | 20                                     | DTR                   |
| CTS                              | 4                                      | RTS                   |



THE SPECIFICATIONS AND INFORMATION REGARDING THE PRODUCTS IN THIS MANUAL ARE SUBJECT TO CHANGE WITHOUT NOTICE. ALL STATEMENTS, INFORMATION, AND RECOMMENDATIONS IN THIS MANUAL ARE BELIEVED TO BE ACCURATE BUT ARE PRESENTED WITHOUT WARRANTY OF ANY KIND, EXPRESS OR IMPLIED. USERS MUST TAKE FULL RESPONSIBILITY FOR THEIR APPLICATION OF ANY PRODUCTS.

THE SOFTWARE LICENSE AND LIMITED WARRANTY FOR THE ACCOMPANYING PRODUCT ARE SET FORTH IN THE INFORMATION PACKET THAT SHIPPED WITH THE PRODUCT AND ARE INCORPORATED HEREIN BY THIS REFERENCE. IF YOU ARE UNABLE TO LOCATE THE SOFTWARE LICENSE OR LIMITED WARRANTY, CONTACT YOUR CISCO REPRESENTATIVE FOR A COPY.

The following information is for FCC compliance of Class A devices: This equipment has been tested and found to comply with the limits for a Class A digital device, pursuant to part 15 of the FCC rules. These limits are designed to provide reasonable protection against harmful interference when the equipment is operated in a commercial environment. This equipment generates, uses, and can radiate radio-frequency energy and, if not installed and used in accordance with the instruction manual, may cause harmful interference to radio communications. Operation of this equipment in a residential area is likely to cause harmful interference, in which case users will be required to correct the interference at their own expense.

The following information is for FCC compliance of Class B devices: This equipment has been tested and found to comply with the limits for a Class B digital device, pursuant to part 15 of the FCC rules. These limits are designed to provide reasonable protection against harmful interference in a residential installation. This equipment generates, uses and can radiate radio frequency energy and, if not installed and used in accordance with the instructions, may cause harmful interference to radio communications. However, there is no guarantee that interference will not occur in a particular installation. If the equipment causes interference to radio or television reception, which can be determined by turning the equipment off and on, users are encouraged to try to correct the interference by using one or more of the following measures:

- Reorient or relocate the receiving antenna.
- Increase the separation between the equipment and receiver.
- Connect the equipment into an outlet on a circuit different from that to which the receiver is connected.
- Consult the dealer or an experienced radio/TV technician for help.

Modifications to this product not authorized by Cisco could void the FCC approval and negate your authority to operate the product.

The Cisco implementation of TCP header compression is an adaptation of a program developed by the University of California, Berkeley (UCB) as part of UCB's public domain version of the UNIX operating system. All rights reserved. Copyright © 1981, Regents of the University of California.

NOTWITHSTANDING ANY OTHER WARRANTY HEREIN, ALL DOCUMENT FILES AND SOFTWARE OF THESE SUPPLIERS ARE PROVIDED "AS IS" WITH ALL FAULTS. CISCO AND THE ABOVE-NAMED SUPPLIERS DISCLAIM ALL WARRANTIES, EXPRESSED OR IMPLIED, INCLUDING, WITHOUT LIMITATION, THOSE OF MERCHANTABILITY, FITNESS FOR A PARTICULAR PURPOSE AND NONINFRINGEMENT OR ARISING FROM A COURSE OF DEALING, USAGE, OR TRADE PRACTICE.

IN NO EVENT SHALL CISCO OR ITS SUPPLIERS BE LIABLE FOR ANY INDIRECT, SPECIAL, CONSEQUENTIAL, OR INCIDENTAL DAMAGES, INCLUDING, WITHOUT LIMITATION, LOST PROFITS OR LOSS OR DAMAGE TO DATA ARISING OUT OF THE USE OR INABILITY TO USE THIS MANUAL, EVEN IF CISCO OR ITS SUPPLIERS HAVE BEEN ADVISED OF THE POSSIBILITY OF SUCH DAMAGES.

Any Internet Protocol (IP) addresses and phone numbers used in this document are not intended to be actual addresses and phone numbers. Any examples, command display output, network topology diagrams, and other figures included in the document are shown for illustrative purposes only. Any use of actual IP addresses or phone numbers in illustrative content is unintentional and coincidental.

All printed copies and duplicate soft copies of this document are considered uncontrolled. See the current online version for the latest version.

Cisco has more than 200 offices worldwide. Addresses and phone numbers are listed on the Cisco website at [www.cisco.com/go/offices](http://www.cisco.com/go/offices).

Cisco and the Cisco logo are trademarks or registered trademarks of Cisco and/or its affiliates in the U.S. and other countries. To view a list of Cisco trademarks, go to this URL: <https://www.cisco.com/c/en/us/about/legal/trademarks.html>. Third-party trademarks mentioned are the property of their respective owners. The use of the word partner does not imply a partnership relationship between Cisco and any other company. (1721R)

© 2021 Cisco Systems, Inc. All rights reserved.

