

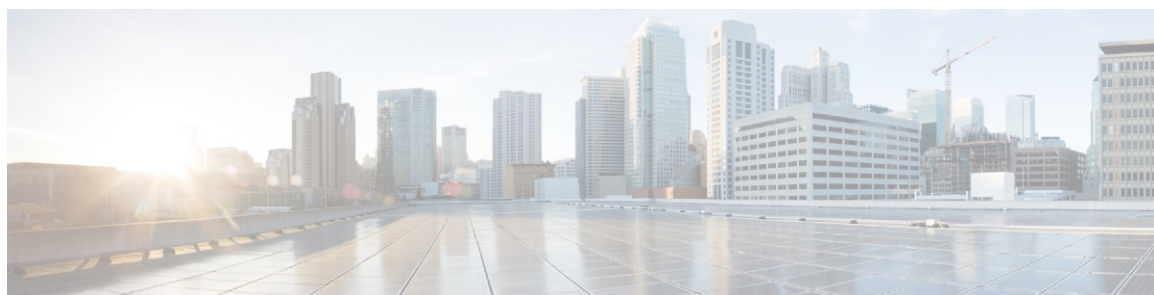


## **Hardware Installation Guide for the Cisco 900 Series Integrated Services Router**

**Last Modified:** 2019-06-07

### **Americas Headquarters**

Cisco Systems, Inc.  
170 West Tasman Drive  
San Jose, CA 95134-1706  
USA  
<https://www.cisco.com>  
Tel: 408 526-4000  
800 553-NETS (6387)  
Fax: 408 527-0883



## CONTENTS

---

<b>CHAPTER 1</b>	<b>Overview of Cisco 900 Series Integrated Services Routers</b>	<b>1</b>
	About Cisco 900 Series Integrated Service Routers	1
	Chassis Views	2
	LED Indicators	11
	Power Supply	13
	Specifications of Cisco 900 Series Integrated Services Routers	14
	Periodic Inspection and Cleaning	14

---

<b>CHAPTER 2</b>	<b>Prepare for Router Installation</b>	<b>15</b>
	Safety Recommendations	15
	Safety With Electricity	15
	Prevent Electrostatic Discharge Damage	16
	General Site Requirements	16
	Site Selection Guidelines	17
	Rack Requirements	18
	Router Environmental Requirements	18
	Power Guidelines and Requirements	19
	Network Cabling Specifications	20
	Console Port Connections	20
	EIA/TIA-232	20
	Console Port Considerations	20
	Preparing for Network Connections	21
	Ethernet Connections	21
	Required Tools and Equipment for Installation	21

---

<b>CHAPTER 3</b>	<b>Install and Connect the Router</b>	<b>23</b>
------------------	---------------------------------------	-----------

- Unpack the Router 23
- Set up Router on Desktop, Rack, Shelf, or Wall 23
  - Rack Mount 24
    - Attach the Brackets to the Router 24
    - Mount the Router 26
  - Wall Mount 27
  - Mount the Router on Desk or Shelf 30
  - Mount the Router under a Desk or a Shelf 31
  - Installing the Micro SIM Card 33
  - Chassis Grounding 34
- Connect Power Cable 35
- Connect the Router to a Console 36
  - Connect to the Serial Port with Microsoft Windows 37
  - Connect to the Console Port with Mac OS X 37
  - Connect to the Console Port with Linux 38
- Connect WAN and LAN Interfaces 38
  - Ports and Cabling 39
  - Connection Procedures and Precautions 39
- Configure the Router at Startup 39

---

- CHAPTER 4 ROM Monitor Overview and Basic Procedures 41**
  - ROM Monitor Overview 41



# CHAPTER 1

## Overview of Cisco 900 Series Integrated Services Routers

Cisco 900 Series Integrated Services Routers (ISRs) with Cisco IOS Software are high-performance devices that are easy to deploy and manage. The routers combine Internet access, comprehensive security, and wireless services (LTE Advanced 3.0, Wireless WAN and Wireless LAN).

- [About Cisco 900 Series Integrated Service Routers, on page 1](#)
- [Periodic Inspection and Cleaning, on page 14](#)

## About Cisco 900 Series Integrated Service Routers

The Cisco 900 series Integrated Services Routers are the SOHO routers that offer unmatched throughput levels. They are available in fixed form factors. The Cisco 900 series is best suited for small and midsize businesses, enterprise branches and as customer premises equipment in managed services environments.

**Table 1: Base models of the Cisco 900 series ISR**

Model	Switch Ports	WAN Ports	Console Ports	DSL
C921-4P	4	2	1	None
C921J-4P	4	2	1	None
C921-4PLTEGB	4	2	1	None
C921-4PLTEAU	4	2	1	None
C921-4PLTEAS	4	2	1	None
C921-4PLTENA	4	2	1	None
C926-4P	4	1	1	1
C926-4PLTEGB	4	1	1	1
C927-4P	4	1	1	1
C927-4PM	4	1	1	1

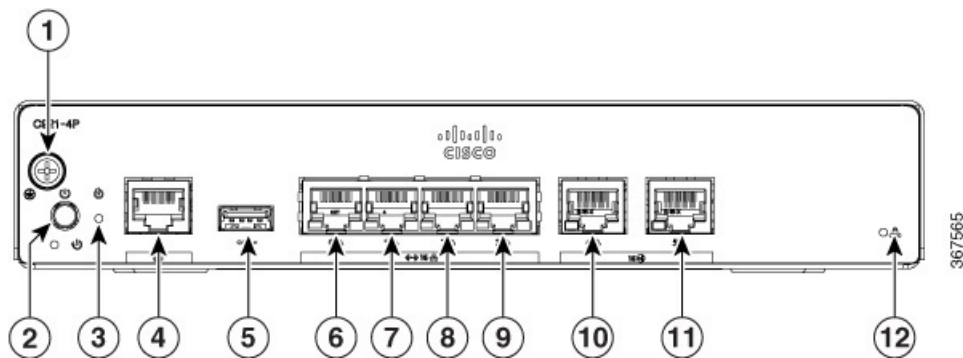
Model	Switch Ports	WAN Ports	Console Ports	DSL
C927-4PLTEGB	4	1	1	1
C927-4PMLTEGB	4	1	1	1
C927-4PLTEAU	4	1	1	1
C931-4P	4	2	1	None

For more information on the features and specifications of Cisco 900 Series Integrated Services Routers (ISRs), refer to the [Cisco 900 Series Integrated Services Routers datasheet](#).

## Chassis Views

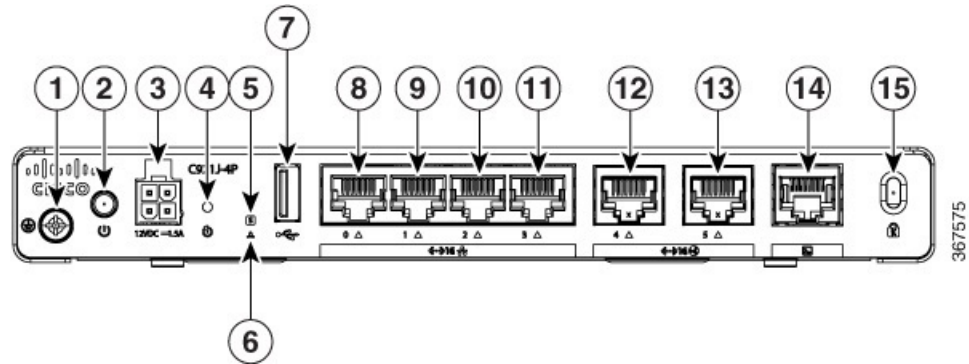
This section contains front and back panel views of the Cisco 900 Series ISR—showing locations of the power and signal interfaces, interface slots, status indicators, and chassis identification labels.

**Figure 1: Cisco C921-4P- I/O View**



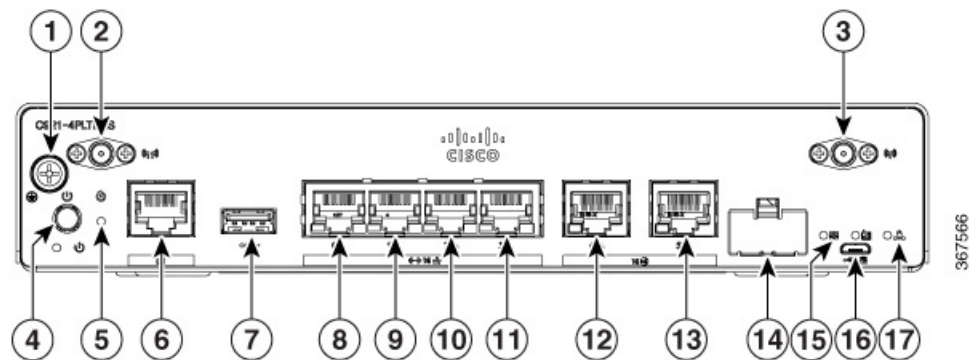
1	#6-32 Ground screw	2	Power button
3	Reset button	4	Console Port
5	USB2.0 port	6	GE LAN port
7	GE LAN port	8	GE LAN port
9	GE LAN port	10	GE WAN port
11	GE WAN port	12	VPN LED

Figure 2: Cisco C921J-4P - I/O View



1	#6-32 Ground screw	2	Power button
3	12VDC input	4	Reset button
5	System LED	6	VPN LED
7	USB2.0 port	8	GE LAN port
9	GE LAN port	10	GE LAN port
11	GE LAN port	12	GE WAN port
13	GE WAN port	14	Console port
15	Kensington Lock		

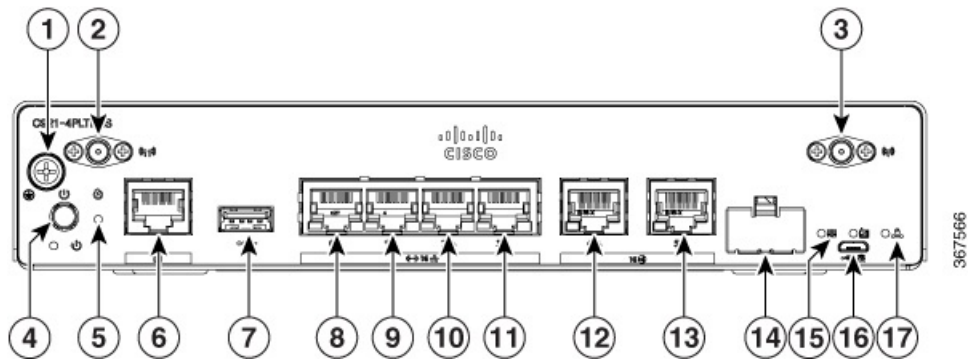
Figure 3: Cisco C921-4PLTENA - I/O View



1	#6-32 Ground screw	2	4G antenna connector—M1/DIV
3	4G antenna connector—M0/MAIN	4	Power button
5	Reset button	6	Console port
7	USB2.0 port	8	GE LAN port

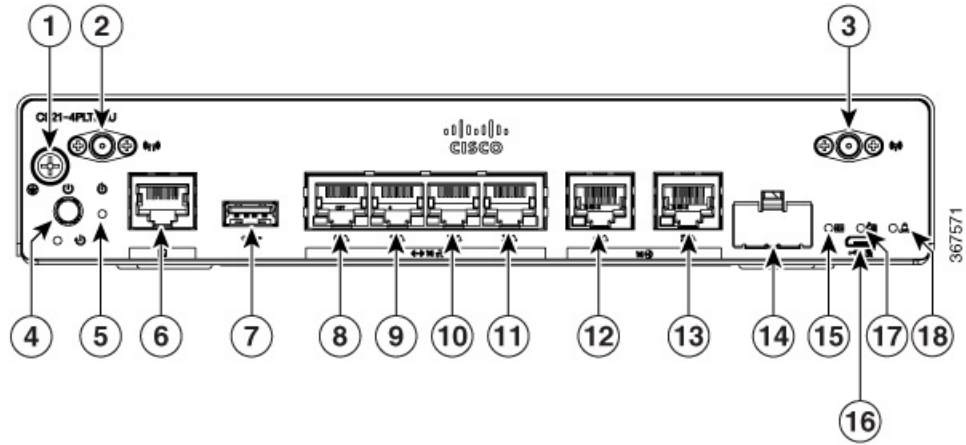
9	GE LAN port	10	GE LAN port
11	GE LAN port	12	GE WAN port
13	GE WAN port	14	Micro SIM port
15	SIM/ACT LED	16	Micro USB port
17	VPN LED		

Figure 4: Cisco C921-4PLTEAS- I/O View



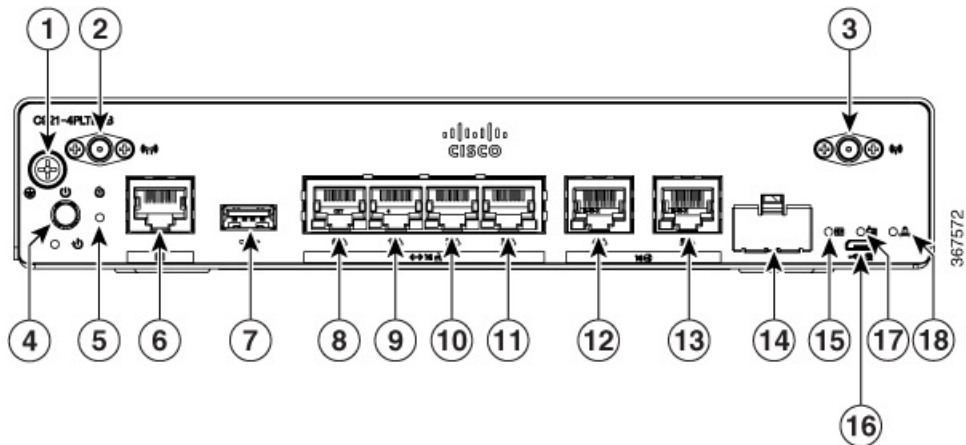
1	#6-32 Ground screw	2	4G antenna connector—M1/DIV
3	4G antenna connector—M0/MAIN	4	Power button
5	Reset button	6	Console port
7	USB2.0 port	8	GE LAN port
9	GE LAN port	10	GE LAN port
11	GE LAN port	12	GE WAN port
13	GE WAN port	14	Micro SIM port
15	SIM/ACT LED	16	Micro USB port
17	VPN LED		

Figure 5: Cisco C921-4PLTEAU - I/O View



1	#6-32 Ground screw	2	4G antenna connector—M1/DIV
3	4G antenna connector—M0/MAIN	4	Power button
5	Reset button	6	Console port
7	USB2.0 port	8	GE LAN port
9	GE LAN port	10	GE LAN port
11	GE LAN port	12	GE WAN port
13	GE WAN port	14	Micro SIM slot
15	SIM/ACT LED	16	Micro USB port
17	RSSI LED	18	VPN LED

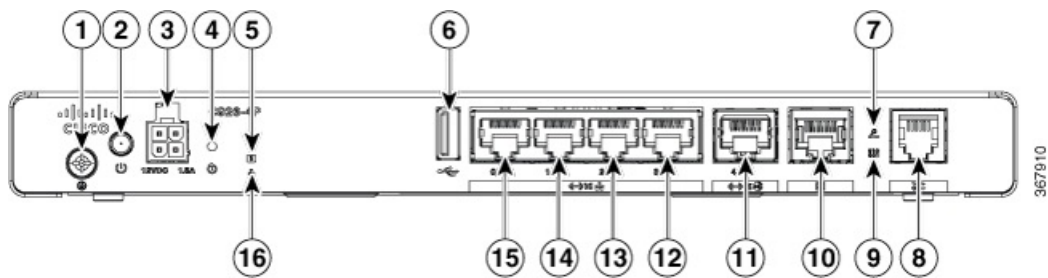
Figure 6: Cisco C921-4PLTEGB - I/O View





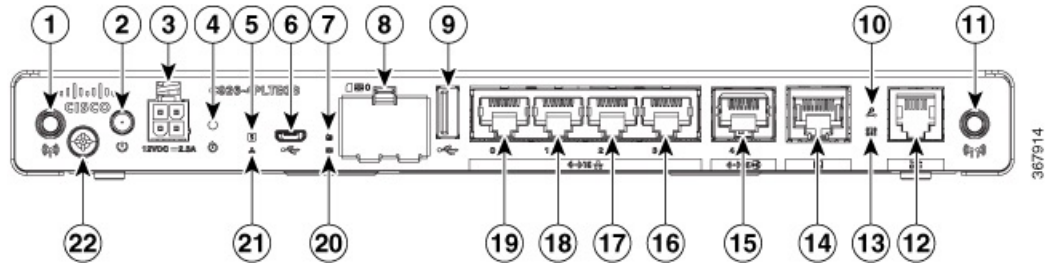
1	#6-32 Ground screw	2	4G antenna connector—M1/DIV
3	4G antenna connector—M0/MAIN	4	Power button
5	Reset button	6	Console port
7	USB2.0 port	8	GE LAN port
9	GE LAN port	10	GE LAN port
11	GE LAN port	12	GE WAN port
13	GE WAN port	14	Micro SIM slot
15	SIM/ACT LED	16	Micro USB port
17	RSSI LED	18	VPN LED

Figure 7: Cisco C926-4P- I/O View



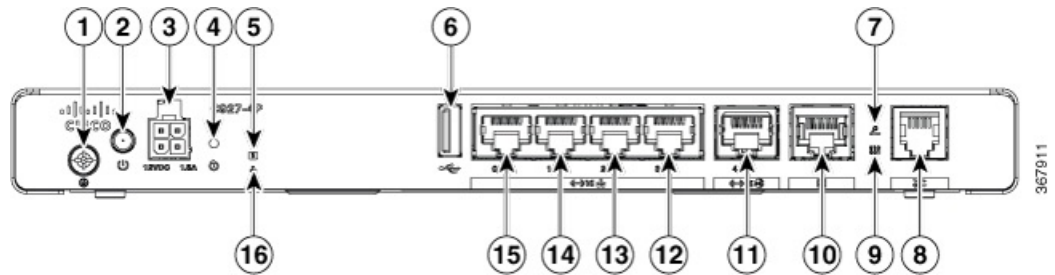
1	#6-32 Ground screw	2	Power button
3	12VDC input	4	Reset button
5	System LED	6	USB2.0 port
7	xDSL CD LED	8	DSL port
9	xDSL DATA LED	10	Console port
11	GE WAN port	12	GE LAN port
13	GE LAN port	14	GE LAN port
15	GE LAN port	16	VPN LED

Figure 8: Cisco C926-4PLTEGB - I/O View



1	Antenna	2	Power button
3	12VDC input	4	Reset button
5	System LED	6	Micro USB
7	RSSI LED	8	SIM card slot
9	USB2.0 port	10	xDSL CD LED
11	Antenna	12	DSL port
13	xDSL DATA LED	14	Console port
15	GE WAN Port	16	GE LAN Port
17	GE LAN Port	18	GE LAN Port
19	GE LAN Port	20	SIM/ACT LED
21	VPN LED	22	#6-32 Ground screw

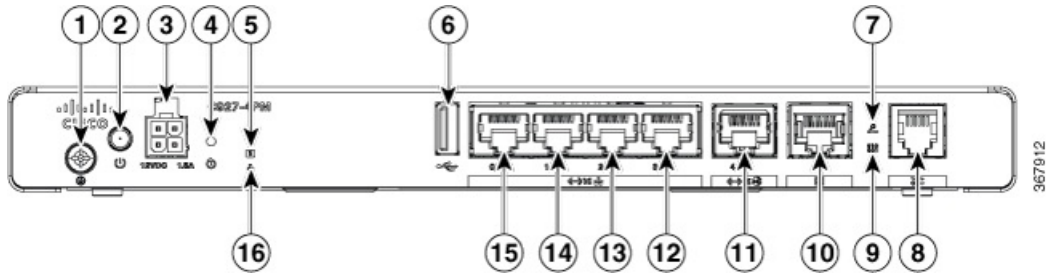
Figure 9: Cisco C927-4P - I/O View



1	#6-32 Ground screw	2	Power button
3	12VDC input	4	Reset button
5	System LED	6	USB2.0 port
7	xDSL CD LED	8	DSL port
9	xDSL DATA LED	10	Console port

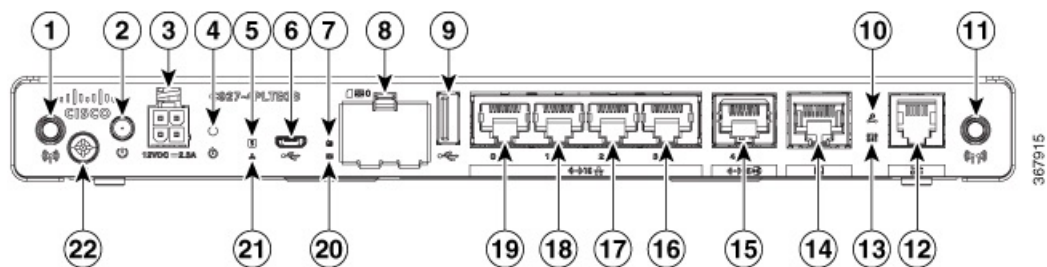
11	GE WAN port	12	GE LAN port
13	GE LAN port	14	GE LAN port
15	GE LAN port	16	VPN LED

Figure 10: Cisco C927-4PM - I/O View



1	#6-32 Ground screw	2	Power button
3	12VDC input	4	Reset button
5	System LED	6	USB2.0 port
7	xDSL CD LED	8	DSL port
9	xDSL DATA LED	10	Console port
11	GE WAN port	12	GE LAN port
13	GE LAN port	14	GE LAN port
15	GE LAN port	16	VPN LED

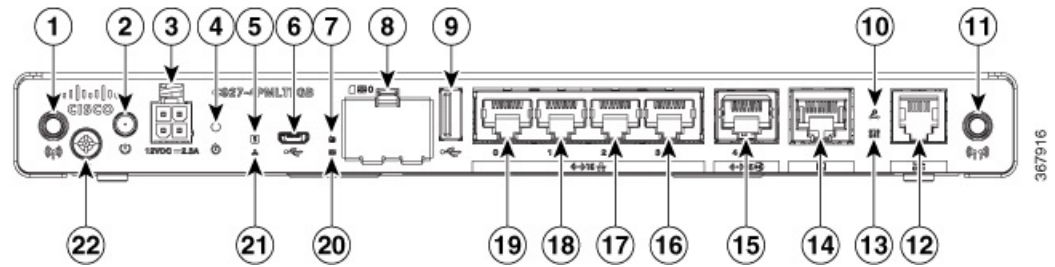
Figure 11: Cisco C927-4PLTEGB - I/O View



1	Antenna	2	Power button
3	12VDC input	4	Reset button
5	System LED	6	Micro USB
7	RSSI LED	8	SIM card slot
9	USB2.0 port	10	xDSL CD LED

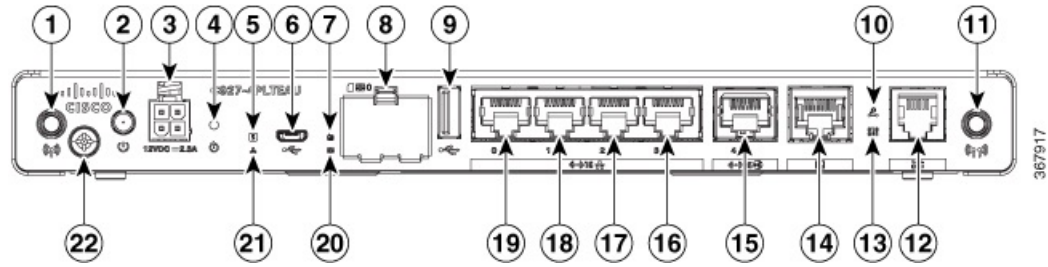
11	Antenna	12	DSL port
13	xDSL DATA LED	14	Console port
15	GE WAN Port	16	GE LAN Port
17	GE LAN Port	18	GE LAN Port
19	GE LAN Port	20	SIM/ACT LED
21	VPN LED	22	#6-32 Ground screw

Figure 12: Cisco C927-4PMLTEGB - I/O View



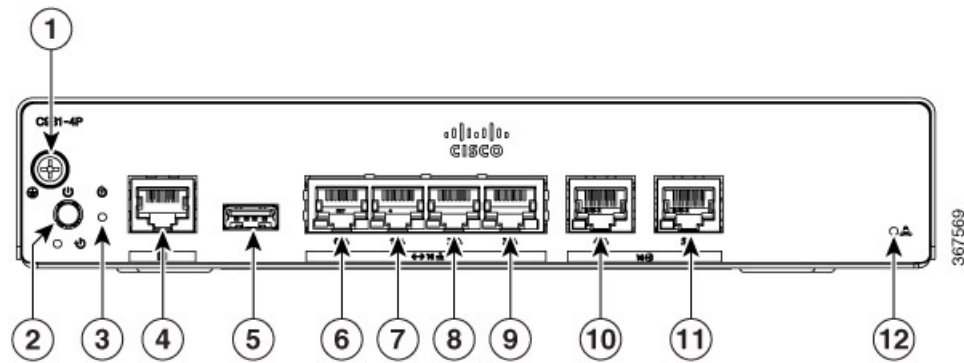
1	Antenna	2	Power button
3	12VDC input	4	Reset button
5	System LED	6	Micro USB
7	RSSI LED	8	SIM card slot
9	USB2.0 port	10	xDSL CD LED
11	Antenna	12	DSL port
13	xDSL DATA LED	14	Console port
15	GE WAN Port	16	GE LAN Port
17	GE LAN Port	18	GE LAN Port
19	GE LAN Port	20	SIM/ACT LED
21	VPN LED	22	#6-32 Ground screw

Figure 13: Cisco C927-4PLTEAU - I/O View



1	Antenna	2	Power button
3	12VDC input	4	Reset button
5	System LED	6	Micro USB
7	RSSI LED	8	SIM card slot
9	USB2.0 port	10	xDSL CD LED
11	Antenna	12	DSL port
13	xDSL DATA LED	14	Console port
15	GE WAN Port	16	GE LAN Port
17	GE LAN Port	18	GE LAN Port
19	GE LAN Port	20	SIM/ACT LED
21	VPN LED	22	#6-32 Ground screw

Figure 14: Cisco C931-4P - I/O View



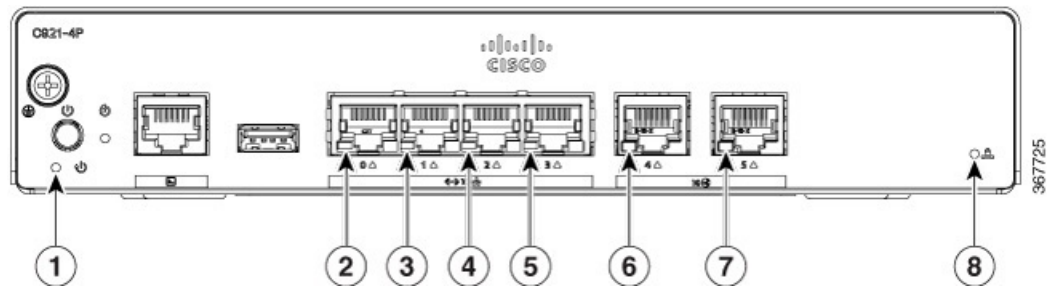
1	#6-32 Ground screw	2	Power button
3	Reset button	4	Console port
5	USB2.0 port	6	GE LAN port
7	GE LAN port	8	GE LAN port

9	GE LAN port	10	GE WAN port
11	GE WAN port	12	VPN LED

## LED Indicators

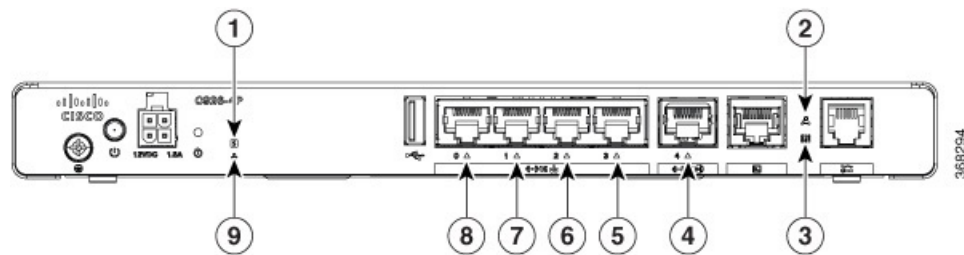
The following figures and table summarize the LED indicators that are located in the bezel or chassis of the 900 series.

**Figure 15: LED Indicators on Ethernet SKUs- I/O Side**



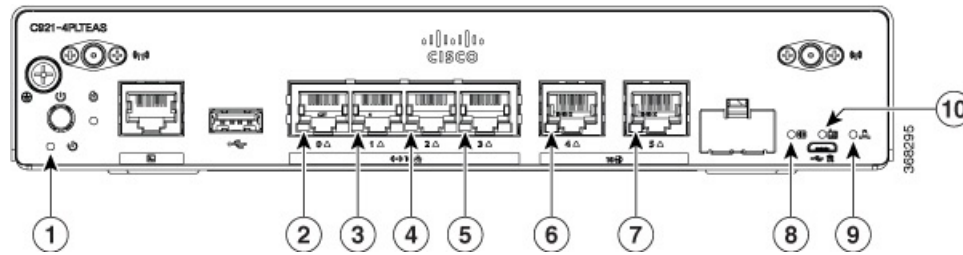
1	Power LED	2	LAN LED
3	LAN LED	4	LAN LED
5	LAN LED	6	WAN LED
7	WAN LED	8	VPN LED

**Figure 16: LED Indicators on DSL SKUs- I/O Side**



1	System LED	2	xDSL CD LED
3	xDSL DATA LED	4	WAN LED
5	LAN LED	6	LAN LED
7	LAN LED	8	LAN LED
9	VPN LED		

Figure 17: LED Indicators on 4G LTE SKUs- I/O Side



1	Power LED	2	LAN LED
3	LAN LED	4	LAN LED
5	LAN LED	6	WAN LED
7	WAN LED	8	SIM/ACT LED
9	VPN LED	10	RSSI LED

The following table summarizes the LED indicators that are located in the chassis of the Cisco ISR 900 series routers.

Table 2: LED Indicators for Cisco ISR 900 Series Routers

Port	LED Color	Description
SYS	OFF	System is off
	Blink	Boot up phase or in ROM Monitor mode
	Steady on	Normal operation
	Amber(steady)	Thermal trip
	Amber(blink)	ROMMON code signing verification failure
VPN OK	Green	At least one VPN session is active
	OFF	VPN not connected
LAN	Green(Solid)	LAN connection is established.
	Green (Blinking)	Data transmission is happening on the link.
	OFF	LAN is not connected

Port	LED Color	Description
WAN	Green(Solid)	WAN link is established
	Green (Blinking)	Data transmission is happening on the link.
	OFF	WAN link is not connected.
DSL CD	OFF	Shut
	Green(Blinking)	Training, or no shut and cable disconnected.
	Green (solid)	Trained
DSL Data	OFF	Shut
	Green(Blinking)	TX/RX Data
RSSI	Green (Solid)	Signal > -60 dBm Very strong signal
	Yellow	60dBm > Signal > -75dBm Strong signal
	Yellow(blinking)	75dBm > Signal > -90dBm Fair signal
	OFF	Signal < -90 dBm Unusable signal
SIM	OFF	No SIM
	Steady on	SIM present in slot
	Blink	TXD/RXD data

## Power Supply

The product power specifications for external power supply units are as follows:

- AC input voltage: Universal 100 to 240 VAC
- Frequency: 50 to 60 Hz
- Maximum output power: 18W or 30W depending on the SKU
- Output voltage: +12VDC for system power



## Specifications of Cisco 900 Series Integrated Services Routers

For specifications on the Cisco 900 Series ISRs, refer to the Cisco 900 series Specifications document.

## Periodic Inspection and Cleaning

We recommend to periodically inspect and clean the external surface of the router to minimize the negative impact from environmental dust or debris. The frequency of inspection and cleaning is dependent upon the severity of the environmental conditions, but we recommend a minimum once in every six months. Cleaning involves vacuuming router air intake and exhaust vents.



---

**Note**

Sites with ambient temperatures consistently above 25°C and with potentially high levels of dust or debris might require periodic preventative maintenance cleaning.

---



## CHAPTER 2

# Prepare for Router Installation

---

Before you install the Cisco 900 Series Integrated Services Routers, you must prepare your site for the installation. This chapter provides pre-installation information, such as recommendations and requirements that should be considered before installing your router.

See the following sections to prepare for installation:

- [Safety Recommendations, on page 15](#)
- [General Site Requirements, on page 16](#)
- [Rack Requirements, on page 18](#)
- [Router Environmental Requirements, on page 18](#)
- [Power Guidelines and Requirements, on page 19](#)
- [Network Cabling Specifications, on page 20](#)
- [Required Tools and Equipment for Installation , on page 21](#)

## Safety Recommendations



---

### **Warning** IMPORTANT SAFETY INSTRUCTIONS

This warning symbol means danger. You are in a situation that could cause bodily injury. Before you work on any equipment, be aware of the hazards involved with electrical circuitry and be familiar with standard practices for preventing accidents. Use the statement number provided at the end of each warning to locate its translation in the translated safety warnings that accompanied this device. Statement 1071

SAVE THESE INSTRUCTIONS

---

## Safety With Electricity



---

### **Warning** No user-serviceable parts inside. Do not open. Statement 1073

---




---

**Warning** Only trained and qualified personnel should be allowed to install, replace, or service this equipment. Statement 1030.

---




---

**Warning** Ultimate disposal of this product should be handled according to all national laws and regulations. Statement 1040.

---

## Prevent Electrostatic Discharge Damage

Electrostatic discharge (ESD) can damage equipment and impair electrical circuitry. It can occur if electronic printed circuit cards are improperly handled and can cause complete or intermittent failures. Always follow ESD prevention procedures when removing and replacing modules:

- Ensure that the router chassis is electrically connected to ground.
- Wear an ESD-preventive wrist strap, ensuring that it makes good skin contact. Connect the clip to an unpainted surface of the chassis frame to channel unwanted ESD voltages safely to ground. To guard against ESD damage and shocks, the wrist strap and cord must operate effectively.
- If no wrist strap is available, ground yourself by touching a metal part of the chassis.




---

**Caution** For the safety of your equipment, periodically check the resistance value of the anti-static strap. It should be between 1 and 10 megohms (Mohm).

---

## General Site Requirements




---

**Warning** Installation of the equipment must comply with local and national electrical codes. Statement 1074

---




---

**Warning** Connect the Chassis to Earth Ground—To reduce the risk of electric shock, the chassis of this equipment needs to be connected to permanent earth ground during normal use. Statement 445

---




---

**Warning** This product relies on the building's installation for short-circuit (overcurrent) protection. Ensure that the protective device is rated not greater than: 20A. Statement 1005

---




---

**Warning** Take care when connecting units to the supply circuit so that wiring is not overloaded. Statement 1018

---

**Warning**

To prevent the system from overheating, do not operate the devices in an area that exceeds the maximum recommended ambient temperature. Statement 1047.

**Table 3: Ambient Temperature of SKUs**

SKU		Ambient Temperature
Internal PSU	C921-4P	50 °C
	C931-4P	
	C921-4PLTENA	45 °C
	C921-4PLTEAS	
	C921-4PLTEAU	
	C921-4PLTEGB	
External PSU	C921J-4P	45 °C
	C926-4P	
	C926-4PLTEGB	
	C927-4P	
	C927-4PM	
	C927-4PLTEGB	
	C927-4PMLTEGB	
	C927-4PLTEAU	

**Note**

For altitudes above sea-level, de-rate the ambient operating temperature 1°C per 1000-feet of elevation.

**Note**

Cisco 900 series routers are fanless, normally run warm to the touch, and require adequate clearances for proper heat dissipation and ventilation.

## Site Selection Guidelines

The Cisco 900 Series ISRs require specific environmental operating conditions. Temperature, humidity, altitude, and vibration can affect the performance and reliability of the router. The following sections provide specific information to help you plan for the proper operating environment.

The Cisco 900 Series ISRs are designed to meet the industry EMC, safety, and environmental standards described in the Regulatory Compliance and Safety Information for the Cisco 900 Series ISR document.

## Rack Requirements

Routers with internal Power Supplies can be mounted in a 19-inch rack using rack-mount brackets (optional kit). Routers with external Power Supplies require a customer-provided tray for mounting in a rack.

The following information helps you plan your equipment rack configuration:

- Allow clearance around the rack for maintenance.
- Allow at least one rack unit of vertical space between routers; more clearance is required when stacking multiple Cisco 900 Series ISRs. Provide adequate heat removal mechanism so that heat does not build up in the rack and the air surrounding the router is well within the specified operating ambient temperature condition.



---

**Note** More spacing may be required depending on the installation environment.

---

- Enclosed racks must have adequate ventilation. Ensure that the rack is not congested, because each router generates heat. An enclosed rack should have louvered sides and a fan to provide cooling air. Heat generated by equipment near the bottom of the rack can be drawn upward into the intake ports of the equipment above it.

## Router Environmental Requirements

Cisco 900 Series ISRs can be installed on a desk or a shelf, under a desk or a shelf, on a wall, and in a rack, depending on the SKU. The location of your router and the layout of your equipment rack or wiring room are extremely important considerations for proper operation. Equipment installed too close together, inadequate ventilation, and inaccessible panels can cause malfunctions and shutdowns, and can make maintenance difficult. Plan your installation site for accessing both front and rear panels of the router.

When planning your site layout and equipment locations, refer to the General Site Requirements , section. If you are currently experiencing shutdowns or an unusually high number of errors with your existing equipment, these precautions and recommendations may help you isolate the cause of failure and prevent future problems.

- Ensure that the room where your router operates has adequate air circulation. Electrical equipment generates heat. Without adequate air circulation, ambient air temperature may not cool equipment to acceptable operating temperatures.
- Always follow ESD-prevention procedures described in the Preventing Electrostatic Discharge Damage to avoid damage to equipment. Damage from static discharge can cause immediate or intermittent equipment failure.
- When equipment installed in a rack (particularly in an enclosed rack) fails, try operating the equipment by itself, if possible. Power off other equipment in the rack (and in adjacent racks) to allow the router under test a maximum of cooling air and clean power.

# Power Guidelines and Requirements

Cisco 900 series routers come with the following power options:

- Routers with internal AC power supply
- Routers with external AC power supply

**Table 4: SKUs with Internal and External Power Supplies**

Power Supply	SKU
Internal	C921-4P
	C921-4PLTENA
	C921-4PLTEAS
	C921-4PLTEAU
	C921-4PLTEGB
	C931-4P
External	C921J-4P
	C926-4P
	C926-4PLTEGB
	C927-4P
	C927-4PM
	C927-4PLTEGB
	C927-4PMLTEGB
	C927-4PLTEAU



**Note** Do not hang the Power Supply Unit (PSU) from the power socket. Place it on a surface.



**Note** Check the power at your site to ensure that you are receiving power that is free of spikes and noise. Install a power conditioner if necessary

Table 5: Power Requirements for Cisco 900 Series ISRs

Power Source	SKU models	Input Rated	Output Rated
18W AC External Power Supply (PWR-18W-AC(=))	<ul style="list-style-type: none"> <li>• C921J-4P</li> </ul>	100-240V, 0.5A	12VDC, 1.5A
30W AC External Power Supply (PWR-30W-AC(=))	<ul style="list-style-type: none"> <li>• C926-4P</li> <li>• C927-4P</li> <li>• C927-4PM</li> <li>• C926-4PLTEGB</li> <li>• C927-4PLTEGB</li> <li>• C927-4PMLTEGB</li> <li>• C927-4PLTEAU</li> </ul>	100-240V, 1.0A	12VDC, 2.5A

## Network Cabling Specifications

The following sections describe the cables and their specifications required to install Cisco 900 Series ISRs:

### Console Port Connections

The Cisco 900 ISR has both EIA/TIA-232 asynchronous (RJ-45) and USB2.0 compliant serial console ports. The console ports do not have any hardware flow control. Shielded USB cables with properly terminated shields are recommended.

#### EIA/TIA-232

Depending on the cable and the adapter used, this port appears as a DTE or DCE device at the end of the cable.

The default parameters for the console port are 9600 baud, 8 data bits, 1 stop bit, and no parity. The console port does not support hardware flow control. For detailed information about installing a console terminal, see the Connecting to a Console Terminal or Modem section.

For cable and port pinouts, see the Cisco Modular Access Router Cable Specifications document available on [cisco.com](http://cisco.com).

### Console Port Considerations

The router includes an asynchronous serial console port. The console ports provide access to the router using a console terminal connected to the console port. This section discusses important cabling information to consider before connecting the router to a console terminal or modem.

Console terminals send data at speeds slower than modems do; therefore, the console port is ideally suited for use with console terminals.

## Preparing for Network Connections

When setting up your router, consider distance limitations and potential electromagnetic interference (EMI) as defined by the applicable local and international regulations.

Network connection considerations are provided for:

See the following online document for more information about network connections and interfaces:

- Cisco Modular Access Router Cable Specifications

## Ethernet Connections

The IEEE has established Ethernet as standard IEEE 802.3. The routers support the following Ethernet implementations:

- 1000BASE-T—1000 Mb/s full-duplex transmission over a Category 5 or better unshielded twisted-pair (UTP) cable. Supports the Ethernet maximum length of 328 feet (100 meters).
- 100BASE-T—100 Mb/s full-duplex transmission over a Category 5 or better unshielded twisted-pair (UTP) cable. Supports the Ethernet maximum length of 328 feet (100 meters).
- 10BASE-T—10 Mb/s full-duplex transmission over a Category 5 or better unshielded twisted-pair (UTP) cable. Supports the Ethernet maximum length of 328 feet (100 meters).

See the Cisco Modular Access Router Cable Specifications document on Cisco.com for information about Ethernet cables, connectors, and pinouts.

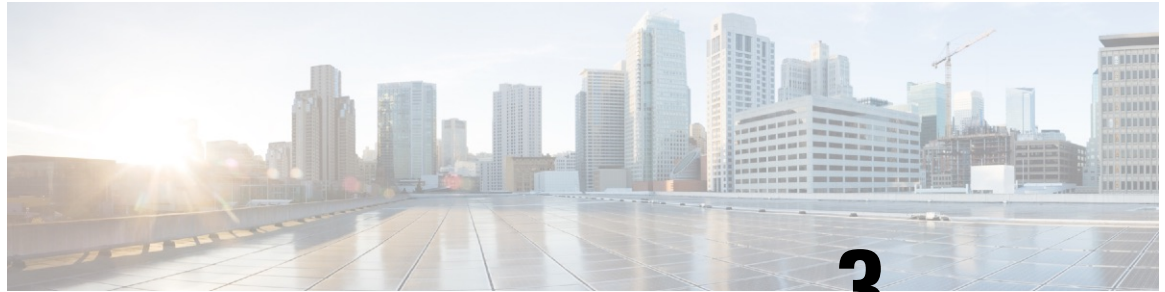
## Required Tools and Equipment for Installation

You need the following tools and equipment to install and upgrade the router and its components:

- ESD-preventive cord and wrist strap
- Number 2 Phillips screwdriver
- Phillips screwdrivers: small, 3/16-in. (4 to 5 mm) and medium, 1/4-in. (6 to 7 mm)
- Screws that fit your rack
- Wire crimper
- Wire for connecting the chassis to an earth ground:
  - AWG 14 (2 mm<sup>2</sup>) or larger wire for chassis grounding
- For grounding, an appropriate user-supplied ring terminal sized appropriately for a #6-32 screw.







## CHAPTER 3

# Install and Connect the Router

This chapter describes how to install and connect Cisco 900 Series Integrated Services Router (ISR) to LAN and WAN networks.



### Warning

Read the installation instructions before using, installing or connecting the system to the power source. Statement 1004

Installing the Cisco 900 Series ISRs involves these tasks:

- [Unpack the Router, on page 23](#)
- [Set up Router on Desktop, Rack, Shelf, or Wall, on page 23](#)
- [Connect Power Cable, on page 35](#)
- [Connect the Router to a Console, on page 36](#)
- [Connect WAN and LAN Interfaces, on page 38](#)
- [Configure the Router at Startup, on page 39](#)

## Unpack the Router

Unpack the router only when you are ready to install it. If the installation site is not ready, to prevent accidental damage, keep the chassis in its shipping container until you are ready to install.

The router, accessory kit, publications, and any optional equipment you order may be shipped in more than one container. When you unpack the containers, check the packing list to ensure that you have received all listed items.

## Set up Router on Desktop, Rack, Shelf, or Wall

After unpacking, based on your requirements, you can set up a Cisco 900 Series Integrated Services Routers (ISRs) on a desk or a shelf, under a desk or a shelf, in a rack, or on a wall.

Depending on the model, the available options for mounting a Cisco 900 ISR are:

Table 6: Models and Mounting Options

SKU		Mounting Options	Kit Required
Internal PSU	C921-4P	On a desk or shelf.	None: Mounting feet are part of the router.
	C921-4PLTENA	Under a desk or shelf.	Yes: You must order Under-desk kit.
	C921-4PLTEAS		
	C921-4PLTEAU	In a rack	Yes: You must order rack-mount-bracket kit.
	C921-4PLTEGB		
C931-4P			
External PSU	C921J-4P	On a desk or shelf.	None: Mounting feet are part of the router.
	C926-4P	In a rack.	None: You must provide your own tray.
	C926-4PLTEGB	On a wall.	None: You must provide wall-mount hardware.
	C927-4P		
	C927-4PM		
	C927-4PLTEGB		
	C927-4PMLTEGB		
	C927-4PLTEAU		

If you choose to setup the router on a desktop, you can place the router on a desktop, bench top, or shelf.

## Rack Mount

Installing the router in a rack requires an optional bracket kit that is not included with the router. You can order these kits from your Cisco representative.



**Note** Cisco 900 Series Routers are fanless. When stacking multiple Cisco 900 ISRs, ensure that there is ample surrounding space. Ample space, in turn, ensures more heat removal to enable the surrounding air temperature to stay within the specified operating conditions. A minimum of 1RU space is required above and below the router in the rack for proper ventilation. Refer [Figure 22: Mounting the Cisco ISR 900 Series Router in a Rack, on page 26](#)

## Attach the Brackets to the Router

This procedure describes how to attach the brackets on the router chassis:

Attach a 19-inch bracket to one side of the router using flat-head screw (Refer [Figure 19: Flat-head Machine Screws, on page 25](#)). Follow the same steps to attach the second bracket to the opposite side.

Figure 18: Attaching Brackets to the Cisco ISR 900 Series Router

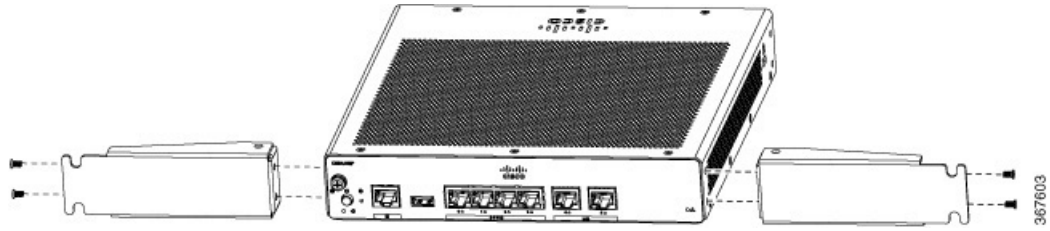


Figure 19: Flat-head Machine Screws

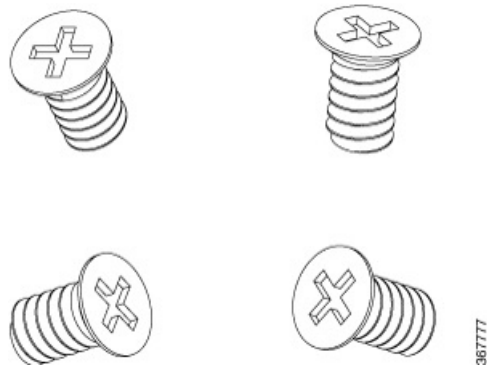


Figure 20: Router with Bracket Attached to Back Panel

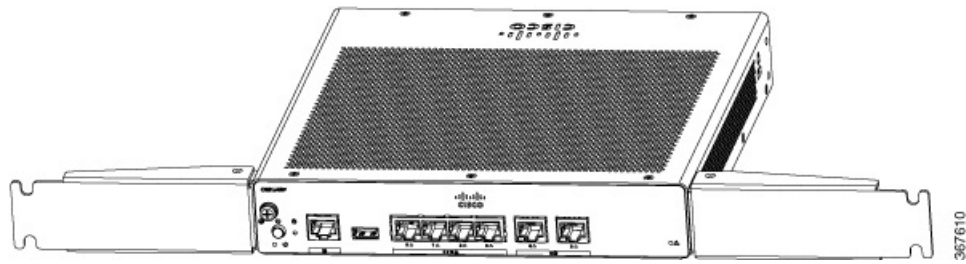
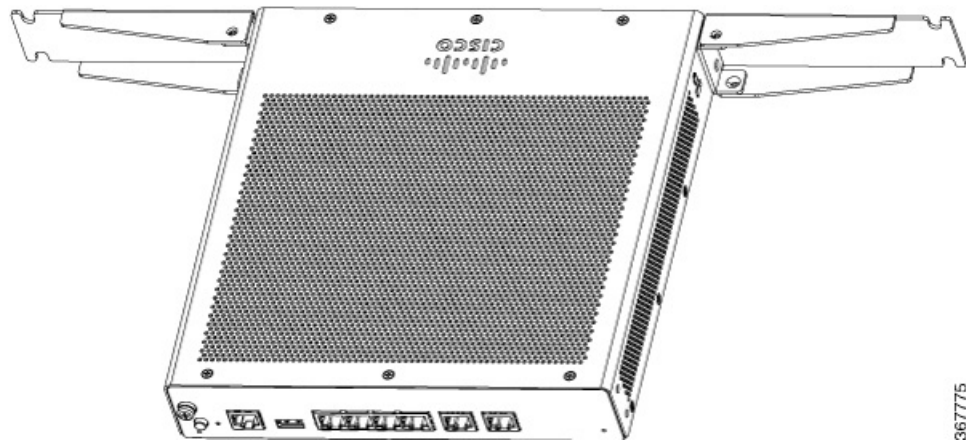


Figure 21: Router with Bracket Attached to Front Panel



## Mount the Router

Before mounting the router on to the rack, refer to the following safety warning statements:



**Warning**

To prevent airflow restriction, allow clearance around the ventilation openings to be at least: 1.75 in. (4.4 cm). Statement 1076.



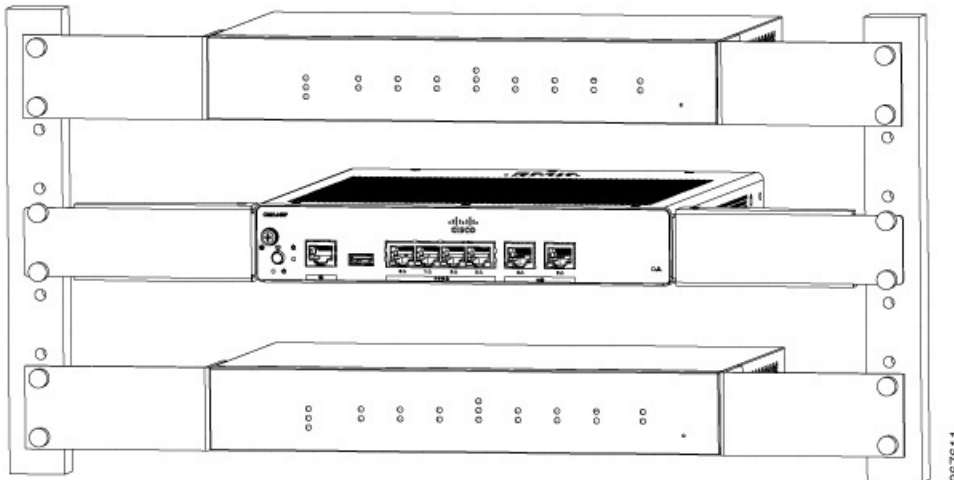
**Warning**

To prevent bodily injury when mounting or servicing this unit in a rack, you must take special precautions to ensure that the system remains stable. The following guidelines are provided to ensure your safety:

- This unit should be mounted at the bottom of the rack if it is the only unit in the rack.
- When mounting this unit in a partially filled rack, load the rack from the bottom to the top with the heaviest component at the bottom of the rack.
- If the rack is provided with stabilizing devices, install the stabilizers before mounting or servicing the unit in the rack. Statement 1006.

After the brackets are attached to the router, insert the router into the rack, and align the bracket in the rack. Use the machine screws to secure the router in the rack.

**Figure 22: Mounting the Cisco ISR 900 Series Router in a Rack**



**Note** Allow at least one rack unit (1RU) of vertical space between routers. More clearance may be required when stacking multiple products in the rack that could build up heat in the rack. Ensure that the ambient around the router is within the ambient temperature specified in [Table 3: Ambient Temperature of SKUs, on page 17](#).

**Note** The local ambient (not room ambient) is measured below the router.

Routers with external power supply can be mounted in a tray as shown in figure below.

Figure 23: Mounting the Cisco ISR 900 Series Router in a Tray



## Wall Mount

Cisco 900 ISRs designed for wall-mounting (refer [Table 6: Models and Mounting Options, on page 24](#)) have mounting holes on the bottom of the chassis for securing with screws or anchors to a vertical surface.



### Warning

Read the wall-mounting instructions carefully before beginning installation. Failure to use the correct hardware or to follow the correct procedures could result in a hazardous situation to people and damage to the system. Statement 378



### Note

The recommended clearance when a router is horizontally mounted is 1.5 inches on both sides for clearance and 1.75 inches on top. I/O side clearance is needed as it is required to access the cable connections. Clearance is not required on the backside (opposite side from I/O face).



### Note

For safety reasons, the only supported wall-mount orientation is as shown in step 3 below. The mounting slots support only this orientation. Marking is provided on the bottom of the router (see step 1) showing the correct orientation.



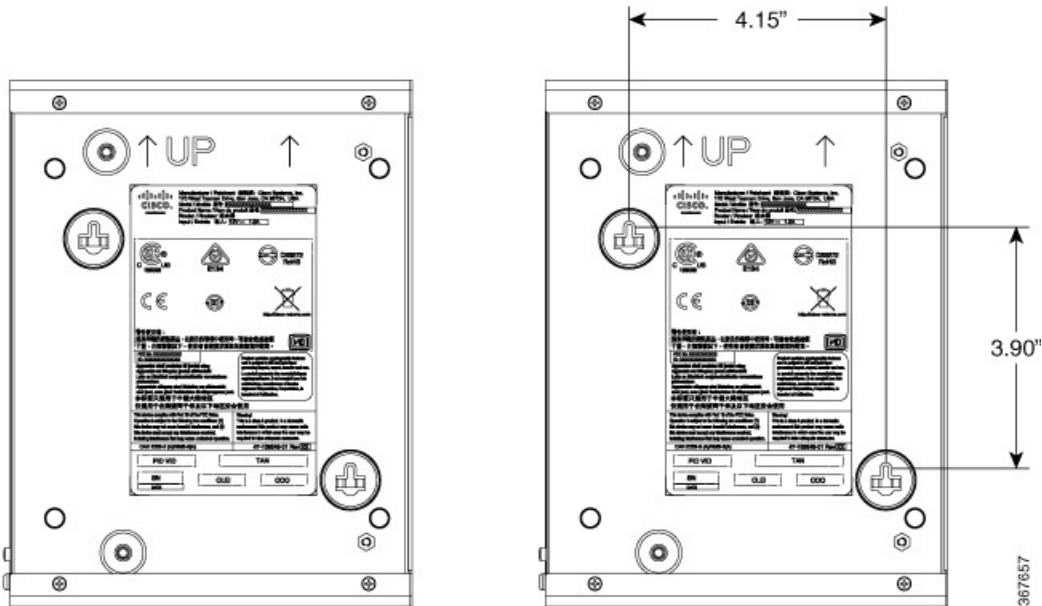
### Note

When choosing a location for wall mounting the router, consider cable limitations and wall structure.

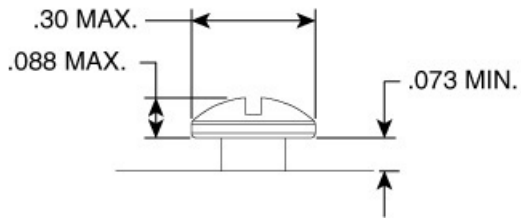
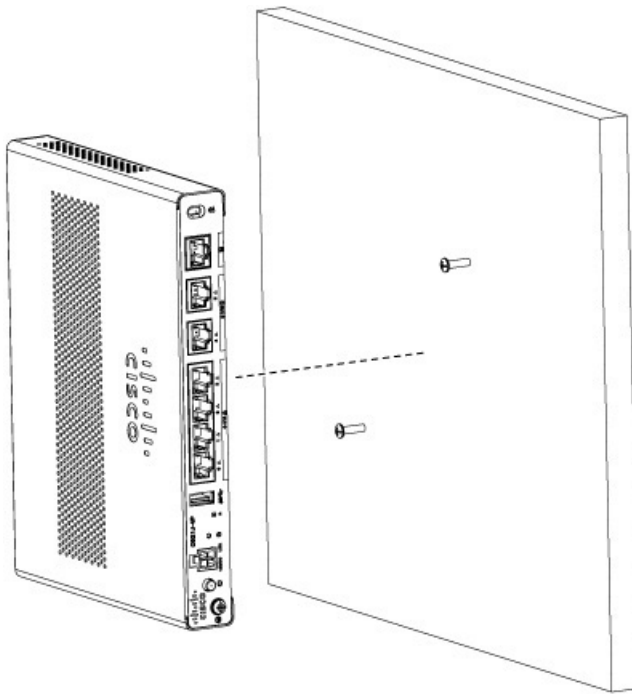
To mount the router on a wall, follow these steps:

- Step 1** Determine the required distance between mounting holes on the router. For Cisco 900 routers, the distance between mounting holes is 4.15 inches. Figure below shows the wall-mount holes located on the underside of the router.

*Figure 24: Router with Wall-mount Holes on the Underside*



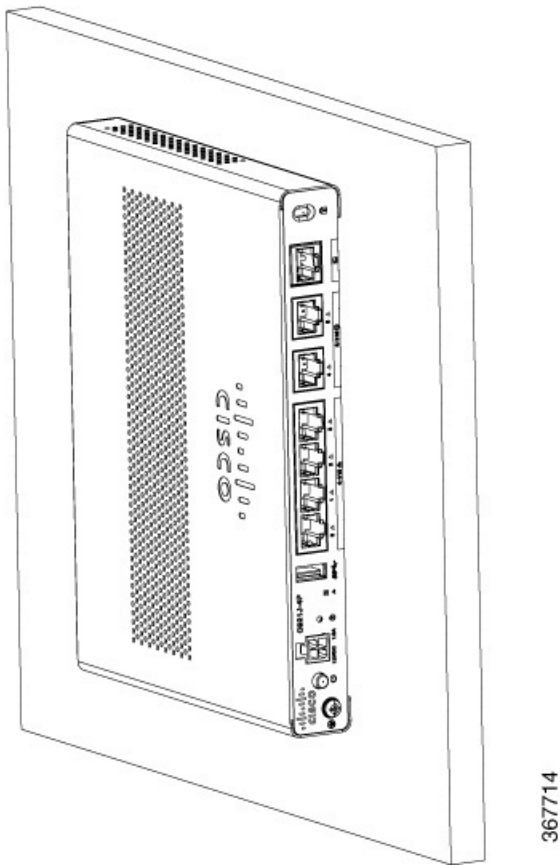
- Step 2** Use a 0.144-inch (3.7 mm) or a #27 drill bit to drill a hole in the wall.
- Step 3** Insert the screws, with anchors, into the wall. Leave 1/8 inch (0.32 cm) between the screw head and the wall.



367715

**Step 4** Hang the router on the screw without forcibly pushing towards the wall side.





## Mount the Router on Desk or Shelf

This procedure describes how to mount router on a desk or a shelf.

Place the router on the desk or shelf. At the bottom of the router there are four rubber feet that protect the router and the surface it is on.

**Figure 25: Mounting the Cisco ISR 900 Series Router on a Desk or a Shelf**

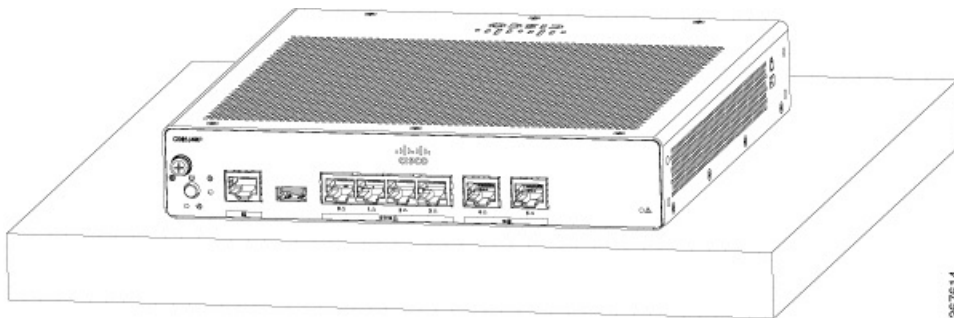
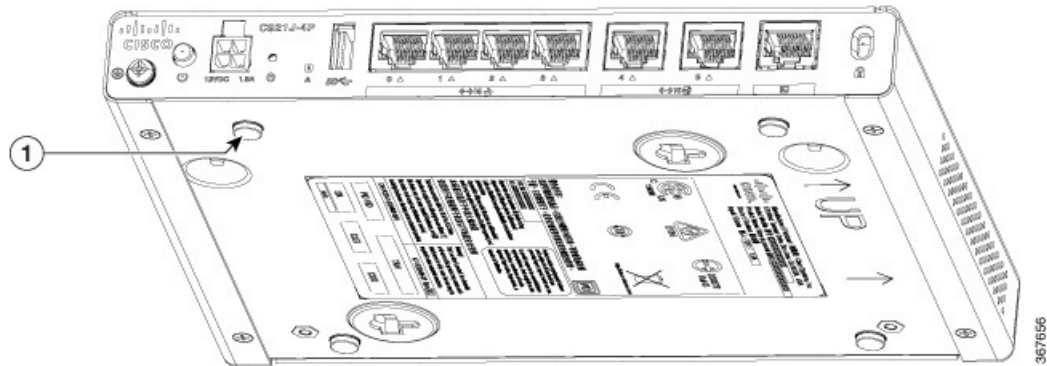
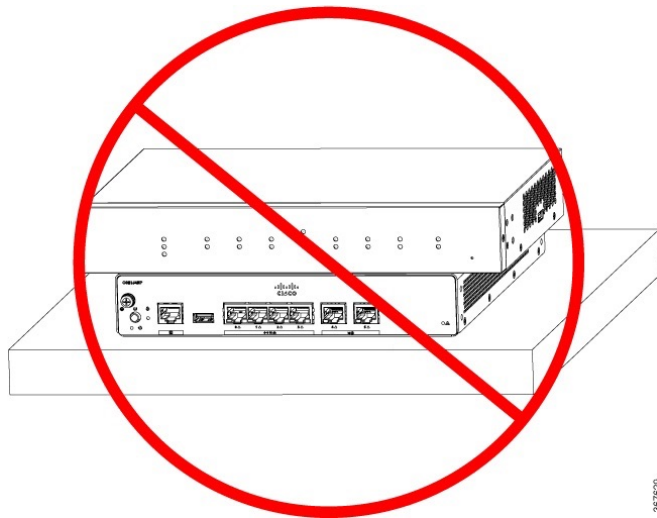


Figure 26: Bottom of the Router with Rubber Feet



## 1. Rubber Feet (1 of 4)

**Note** Do not stack up routers.



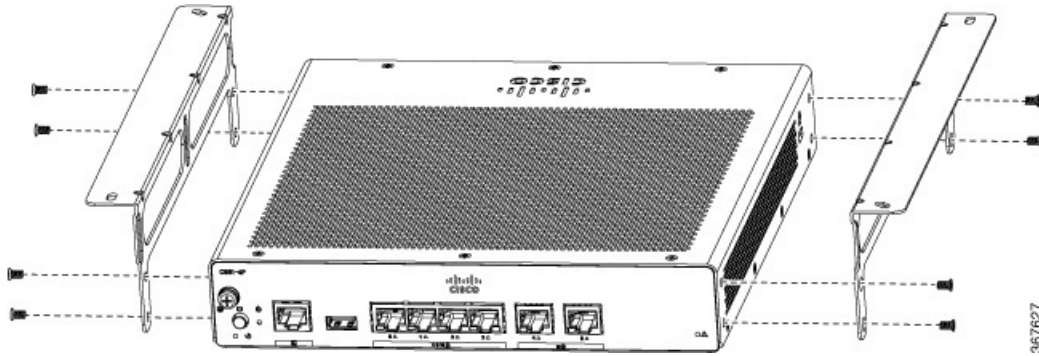
## Mount the Router under a Desk or a Shelf

Installing the router under a desk requires an optional bracket kit that is not included with the router. The kit contains the rack-mount brackets and screws to secure the brackets to the router and the underside of the desk. You can order these kits from your Cisco representative. This procedure describes how to mount router under a desk or a shelf.

### Step 1

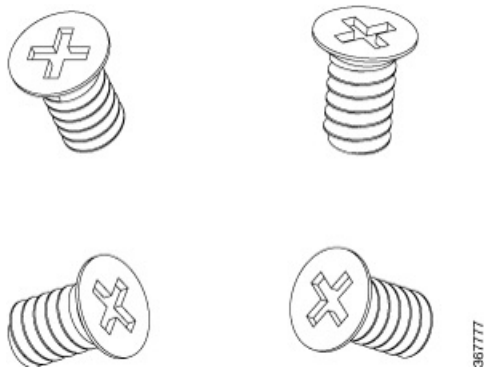
Attach a bracket to one side of the router using the flat-head screws (Refer [Figure 28: Flat-head Machine Screws](#), on page 32). Follow the same steps to attach the second bracket to the opposite side.

Figure 27: Attaching Brackets to the Router



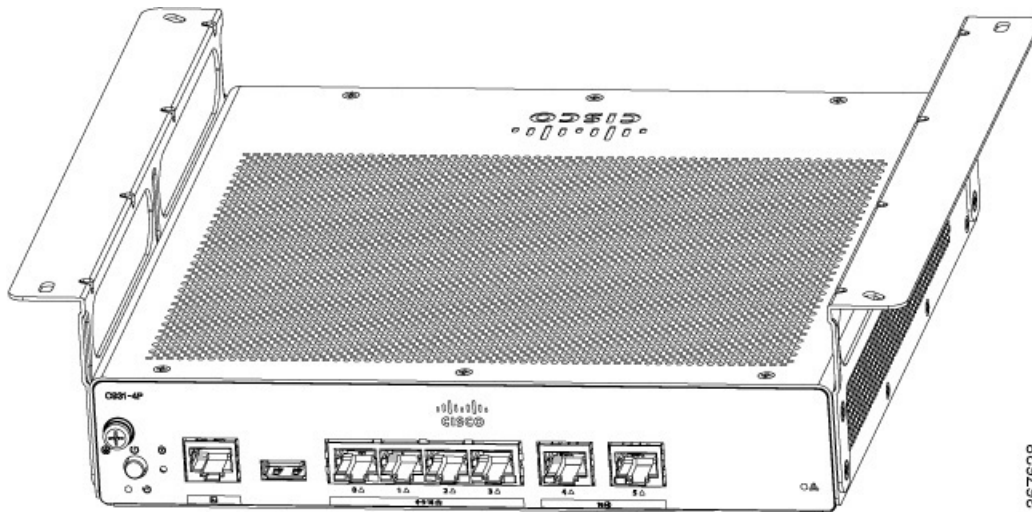
367627

Figure 28: Flat-head Machine Screws



367777

Figure 29: Router with Brackets Attached

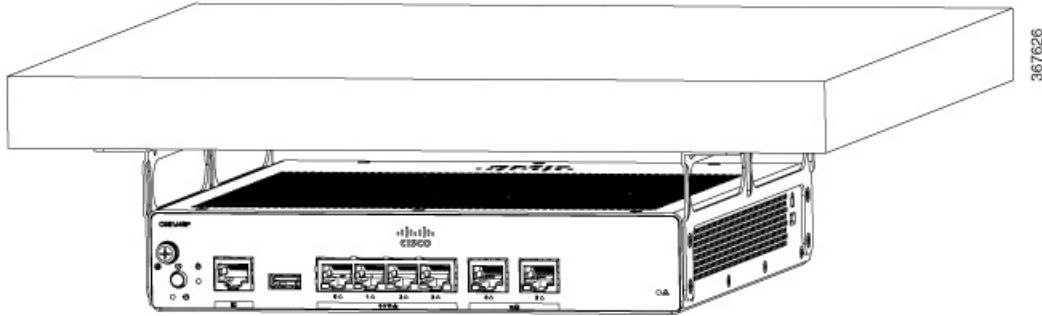


367628

**Step 2**

After the brackets are attached, drill a 2 mm hole under the desk and insert the wooden screws provided. Mount the router under the desk or shelf using the pan-head wood screws (Refer [Figure 31: Pan-head Wood Screws](#), on page 33 ).

**Figure 30: Mounting the Router under a Desk or Shelf**



**Figure 31: Pan-head Wood Screws**



## Installing the Micro SIM Card

This section describes how to install and replace the SIM card.



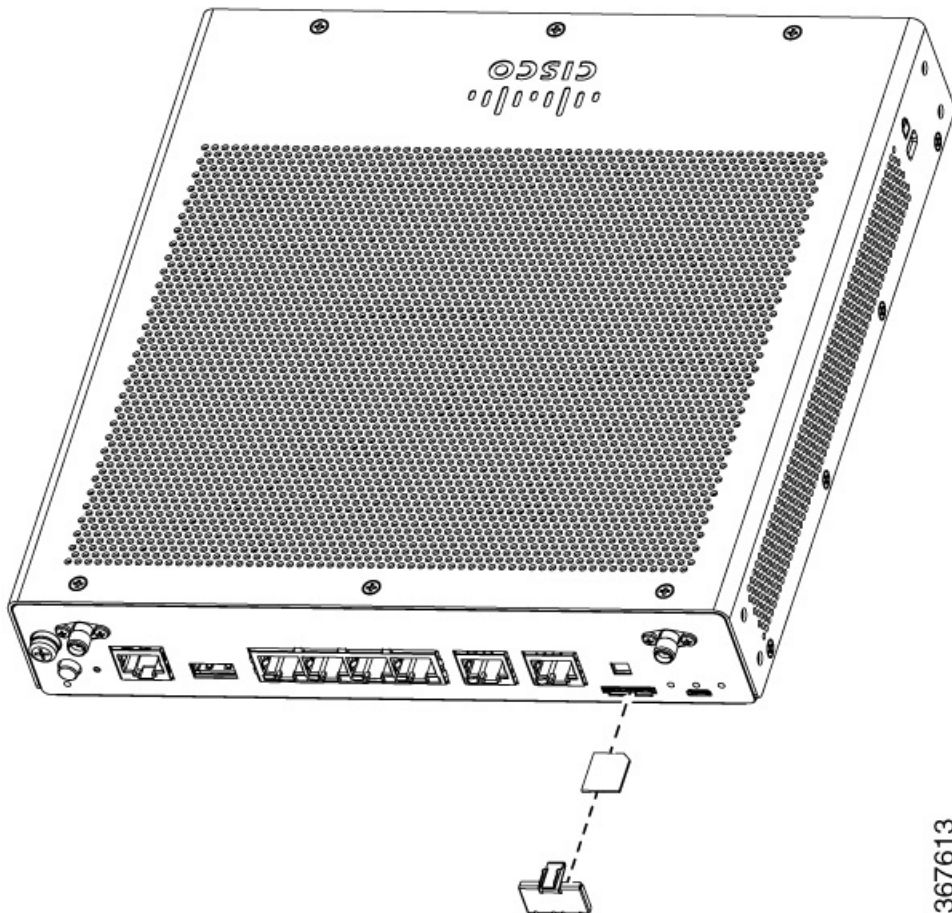
**Note** Do not touch any part of the exposed PCB circuit area when the SIM cover is removed.



**Note** Make sure that the router is powered off before inserting or removing SIM card.

- Step 1** Power off the router and disconnect the power cable from the power source.
- Step 2** Remove the SIM cover plate by depressing the latch. Use a small flat-head screw-driver to depress the latch.

Figure 32: Installing the SIM card



- Step 3** Insert the SIM card by pushing it into the slot. Note that the orientation of the SIM card is important and an icon is shown on the front of the router to assist you.
- Step 4** After inserting the SIM card, replace the cover plate.

## Chassis Grounding

After you set up the router, connect the chassis to a reliable earth ground; the ground wire must be installed in accordance with local electrical safety standards. For safety information on grounding the chassis, refer to the chassis ground connection procedures.

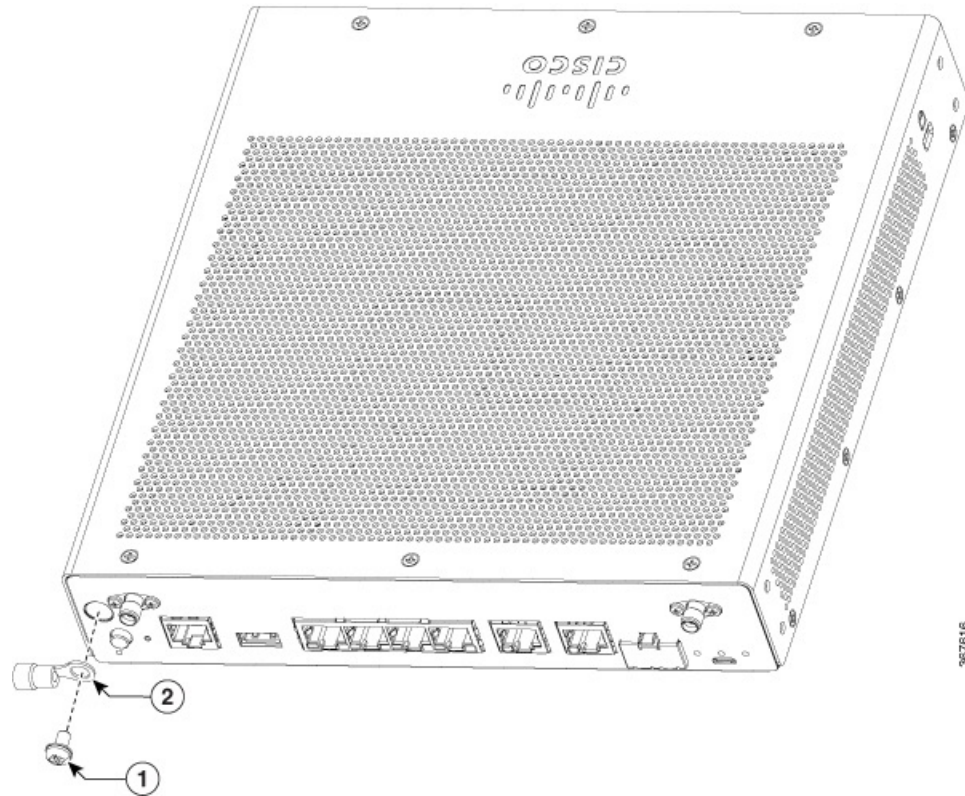
1. For grounding the chassis, use size 14 AWG copper wire and the ground lug. These are not a part of the accessory kit.
2. Use the UNC 6-32 screw provided with the chassis, which have a length of about 0.25 inches.

To install the ground connection for your router, perform these steps:

1. Strip one end of the ground wire to the length required for the ground lug or terminal.
  - For user-provided ring terminal—as required

2. Crimp the ground wire to the ground lug or ring terminal, using a crimp tool of the appropriate size.
3. Attach the ground lug or ring terminal to the chassis as shown in [Figure 33: Chassis Ground Connection-Cisco 900](#), on page 35. The screw for the ground lug is provided. Tighten the screw; the recommended torque is 8 to 10 inch-lbf (0.9 to 1.1 N-m).

**Figure 33: Chassis Ground Connection-Cisco 900**



1	Screw (UNC 6-32)
2	Ground Lug

## Connect Power Cable

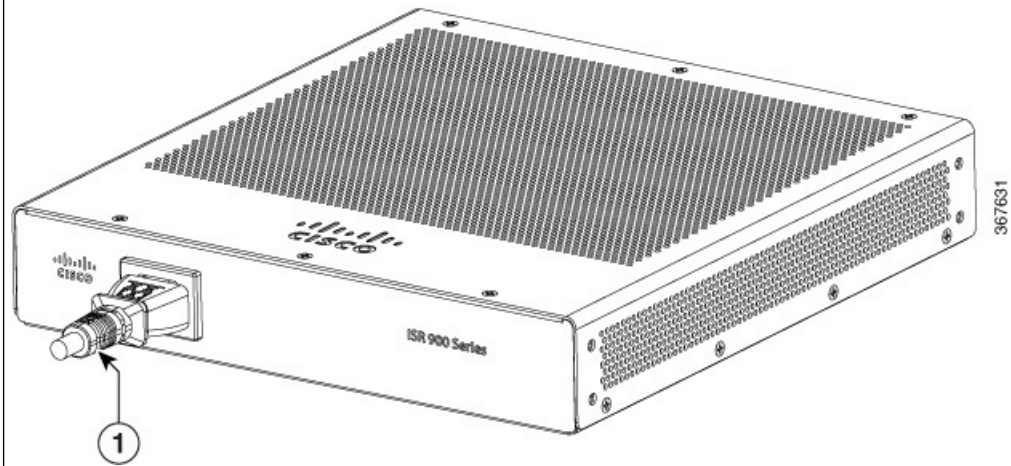
Cisco 900 series routers come with the following power options:

- Routers with internal AC power supply
- Routers with external AC power supply

To power the units that come with an internal power supply, plug in the power cord directly to the power socket in the front panel. To power the units that come with an external power supply, plug in the DC power supply to the router's 4-pin power connector in the back panel.

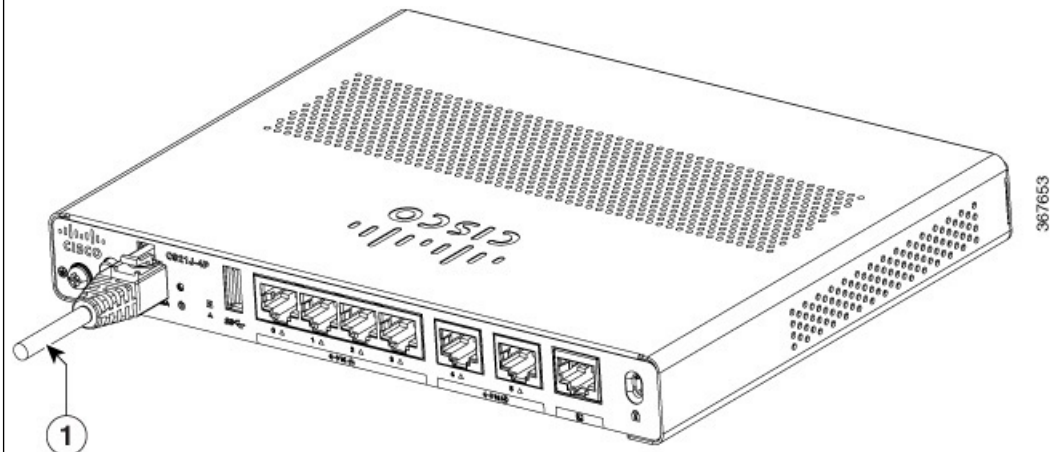


Figure 34: Router with Internal Power Supply



1. Power Cable

Figure 35: Router with External Power Supply



1. Power Cable

## Connect the Router to a Console

The Cisco 900 Series ISR has an asynchronous serial port. This port provides administrative access to the router through a console terminal or a PC.

Use the RJ-45 console port on the router to access the Cisco Internet Operating System (IOS) command line interface (CLI) on the router and perform configuration tasks. A terminal emulation program is required to establish communication between the router and a PC.

To configure the router through the Cisco IOS CLI, you must establish a connection between the router console port and either a PC or a terminal.

Use the following cables and adapters to establish a local or remote connection.

**Table 7: Local and Remote Connections**

Port Type	Cable	Section
Serial (RJ-45)	Cisco 900 ISR: RJ-45 Serial console cable	Connecting to the Serial Port with Microsoft Windows

## Connect to the Serial Port with Microsoft Windows

To establish a physical connectivity between the router and a PC, you need to install a Microsoft Windows USB.

Use the USB Console cable plugged into the USB serial port to establish this connection.β

1. Connect the end of the console cable with the RJ-45 connector to the light blue console port on the router.
2. Connect the end of the cable with the DB-9 connector (or USB Type-A) to the terminal or PC. If your terminal or PC has a console port that does not accommodate a DB-9 connector, you must provide an appropriate adapter for that port.
3. Start a terminal emulator application to communicate with the router. Configure the software with the following parameters:
  - 9600 baud
  - 8 data bits
  - no parity
  - 1 stop bit
  - no flow control

## Connect to the Console Port with Mac OS X

This procedure describes how to connect a Mac OS X system USB port to the console using the built in OS X Terminal utility.

- 
- Step 1** Use the Finder to go to Applications > Utilities > Terminal.
- Step 2** Connect the OS X USB port to the router.
- Step 3** Enter the following commands to find the OS X USB port number

**Example:**

```
macbook:user$ cd /dev
macbook:user$ ls -ltr /dev/*usb*
crw-rw-rw-  1 root  wheel           9,  66 Apr  1 16:46 tty.usbmodem1a21 DT-macbook:dev user$
```

- Step 4** Connect to the USB port with the following command followed by the router USB port speed

**Example:**



```
macbook:user$ screen /dev/tty.usbmodem1a21 9600
```

**To disconnect the OS X USB console from the Terminal window**

Enter Ctrl-a followed by Ctrl-\

---

## Connect to the Console Port with Linux

This procedure shows how to connect a Linux system USB port to the console using the built in Linux Terminal utility.

---

- Step 1** Open the Linux Terminal window.
- Step 2** Connect the Linux USB port to the router.
- Step 3** Enter the following commands to find the Linux USB port number

**Example:**

```
root@usb-suse# cd /dev
root@usb-suse /dev# ls -ltr *ACM*
crw-r--r--  1 root  root   188,  0 Jan 14 18:02 ttyACM0
root@usb-suse /dev#
```

- Step 4** Connect to the USB port with the following command followed by the router USB port speed

**Example:**

```
root@usb-suse /dev# screen /dev/ttyACM0 9600
```

**To disconnect the Linux USB console from the Terminal window**

Enter Ctrl-a followed by : then quit

---

## Connect WAN and LAN Interfaces

This section describes how to connect WAN and LAN interface cables. Before you connect the interface cables, refer to the following warning statements:



**Warning**

For connections outside the building where the equipment is installed, the following ports must be connected through an approved network termination unit with integral circuit protection: LAN. Statement 1044.

---



**Warning**

Avoid using or servicing any equipment that has outdoor connections during an electrical storm. There may be a risk of electric shock from lightning. Statement 1088.

---

## Ports and Cabling

This section summarizes typical WAN and LAN connections for Cisco 900 Series ISRs. The connections summarized here are described in detail in the Cisco Modular Access Router Cable Specifications document on cisco.com.

*Table 8: WAN and LAN Connections*

Port or Connection	Port Type, Color <sup>1</sup>	Connection	Cable
Ethernet	RJ-45, yellow	Ethernet hub or Ethernet switch	Category 5 or higher Ethernet

<sup>1</sup> Cable color codes are specific to Cisco cables.

## Connection Procedures and Precautions

After you have installed the router chassis, perform these steps to connect the WAN and LAN interfaces:

- Connect each WAN and LAN to the appropriate connector on the chassis.
- Position the cables carefully so that you do not strain the connectors.
- Organize cables in bundles so that cables do not intertwine.
- Inspect the cables to make sure that the routing and bend radius is satisfactory. If necessary, reposition the cables.
- Install cable ties in accordance with site requirements.

## Configure the Router at Startup

After installing the router and connecting the cables, you can configure the router with basic configurations. For more information on how to configure the router, see the [Cisco 900 Series Software Configuration Guide](#).





## CHAPTER 4

# ROM Monitor Overview and Basic Procedures

---

The ROM Monitor (ROMMON) is a bootstrap program that initializes the hardware and boots the Cisco 900 ISR when you power on or reload a router.

If your router does not find a valid system image to load when it is booting, the system enters the ROMMON mode. ROMMON mode can also be accessed by interrupting the boot sequence during startup.

- [ROM Monitor Overview, on page 41](#)

## ROM Monitor Overview

The *ROM Monitor software* is also known as *ROMMON*, *boot software*, *boot image*, or *boot helper*. Although it is distributed with routers that use the Cisco IOS software, the ROMMON is a separate program from the Cisco IOS software. During normal startup, ROMMON initializes the router, and then, the control passes to the Cisco IOS software.

When you connect a terminal to the router that is in ROMMON mode, the ROMMON command-line interface (CLI) prompt is displayed.

Access the ROMMON mode to perform these tasks:

- Specify config-register value to use for the next boot up
- Boot a valid IOS image
- Bypass NVRAM settings and config-register value for password recovery



---

**Note** After the Cisco IOS software boots up, ROMMON is no longer in use.

---

### Environmental Variables and the Configuration Register

Two primary connections exist between ROMMON and the Cisco IOS software: the ROMMON environment variables and the configuration register.

The ROMMON environment variables define the location of the Cisco IOS software and describe how to load it. After ROMMON has initialized the router, it uses the environment variables to locate and load the Cisco IOS software.

The *configuration register* is a software setting that controls how a router starts up. One of the primary uses of the configuration register setting is to control whether the router starts in ROMMON mode or Administration EXEC mode. The configuration register is set in either ROMMON mode or Administration EXEC mode as needed. You can set the configuration register using the Cisco IOS software prompt when you need to use ROMMON mode. When maintenance in ROMMON mode is complete, change the configuration register back so that the router reboots with the Cisco IOS software.

### **Access ROMMON Mode with a Terminal Connection**

When the router is in ROMMON mode, you can access the ROMMON software only from a terminal connected directly to the console port of the card. Because the Cisco IOS software (EXEC mode) is in operation, the nonmanagement interfaces are not accessible. Therefore, all Cisco IOS software resources are unavailable.

### **Network Management Access and ROMMON Mode**

ROMMON mode is a router mode, not a mode within the Cisco IOS software. The ROMMON software and the Cisco IOS software are two separate programs that run on the same router. At any given time, the router is running one of these programs, but it never runs both at the same time.

One area that can be confusing when using ROMMON and the Cisco IOS software is the area that defines the IP configuration for the Management Ethernet interface. Most users are comfortable with configuring the Management Ethernet interface in the Cisco IOS software. When the router is in ROMMON mode, however, the router is not running the Cisco IOS software, therefore, Management Ethernet interface configuration is not available.

When you want to access other devices, such as a TFTP server, while in ROMMON mode on the router, you must configure the ROMMON variables with IP access information.

For more information on ROMMON and Basic Procedures, see [Cisco ISR 900 Software Configuration Guide](#).